

**EDCO**<sup>®</sup>  
product

**2010**

# guide

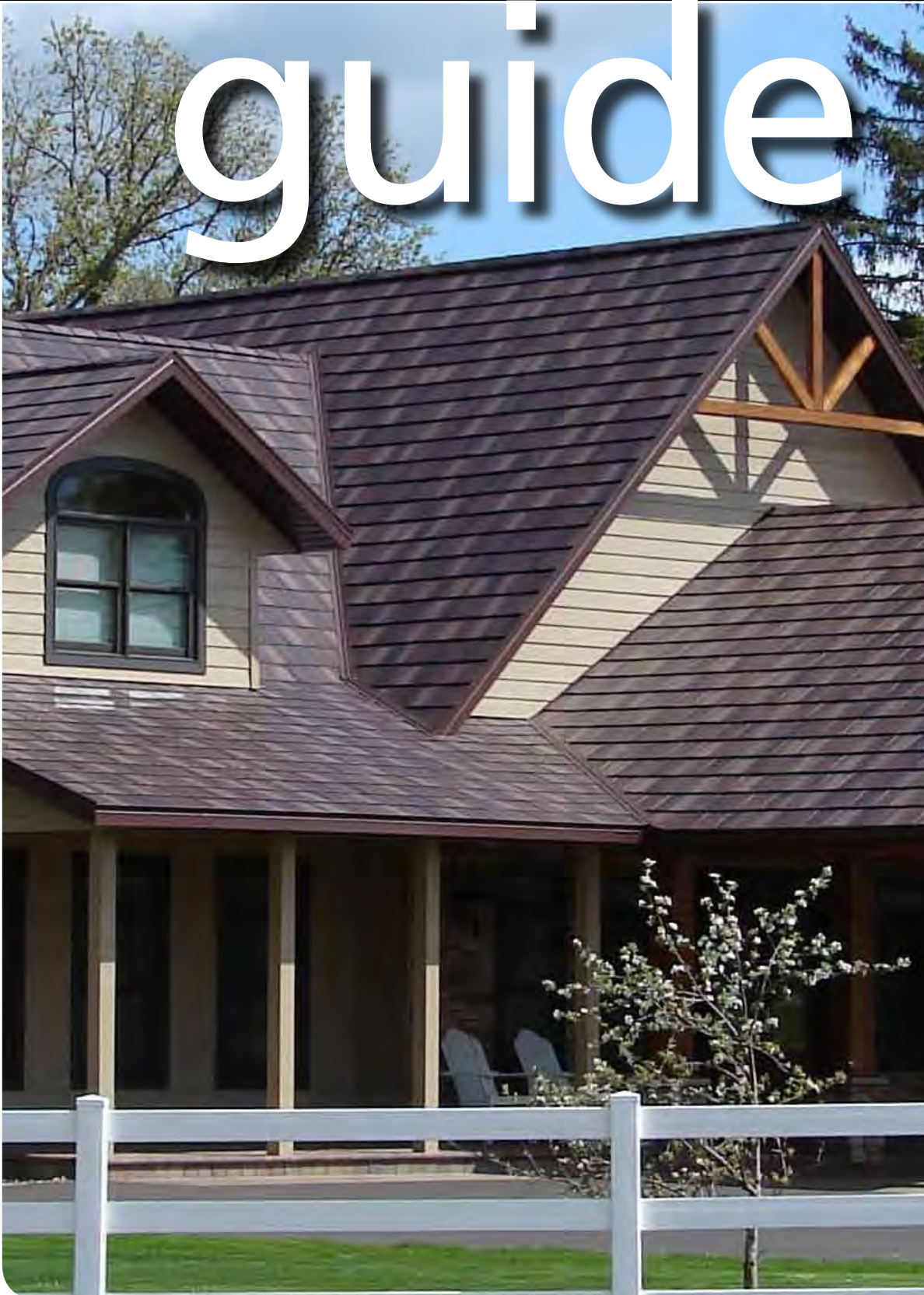

**Creating Quality  
Exteriors Since  
1946**

**SIDING**

**SOFFIT**

**FASCIA**

**METAL ROOFING**

**RAINWARE**

**TRIM COIL**

# Color Availability Matrix

4" Colonial Steel Siding	5" Dutch-Lap Steel Siding	6" Colonial Steel Siding	8" Clapboard Steel Siding	12" Vertical Batten Steel Siding	5" O.G. Gutter	3x4 Downspout: Aluminum	2x3 Downspout: Steel	2x3 Downspout: Aluminum	Soffit: Plain & Center Vented	Soffit: Full Vented	Fascia: Steel	Roof Drip Edge	Snap-On Frieze Trim	1-1/4" Wide-Face J-Trim	F-Trim	7/16" J-Trim	Mitre Molding	Coil Stock (See p24)	Steel Trim Nails		
<b>PVC COLORS</b>																					
●	●	●	●	●	●	●	●	●	●	●	●	●	●	●	●	●	●	●	●	● ●	Glacier White
●	●	●	●	●	●	●	●	●	●	●	●	●	●	●	●	●	●	●	●	● ●	Colonial White
●	●	●	●	●	●	●	●	●	●	●	●	●	●	●	●	●	●	●	●	● ●	Antique Parchment
●	●	●	●	●	●	●	●	●	●	●	●	●	●	●	●	●	●	●	●	● ●	Desert Tone
●	●	●	●	●	●	●	●	●	●	●	●	●	●	●	●	●	●	●	●	● ●	Wickertone
●	●	●	●	●	●	●	●	●	●	●	●	●	●	●	●	●	●	●	●	● ●	Sand Beige
●	●	●	●	●	●	●	●	●	●	●	●	●	●	●	●	●	●	●	●	● ●	Claytone
●	●	●	●	●	●	●	●	●	●	●	●	●	●	●	●	●	●	●	●	● ●	Driftwood Gray
●	●	●	●	●	●	●	●	●	●	●	●	●	●	●	●	●	●	●	●	● ●	Charcoal Gray
●	●	●	●	●	●	●	●	●	●	●	●	●	●	●	●	●	●	●	●	● ●	Slate Blue
●	●	●	●	●	●	●	●	●	●	●	●	●	●	●	●	●	●	●	●	● ●	Heritage Blue
●	●	●	●	●	●	●	●	●	●	●	●	●	●	●	●	●	●	●	●	● ●	Spring Green
●	●	●	●	●	●	●	●	●	●	●	●	●	●	●	●	●	●	●	●	● ●	Sherwood Green
●	●	●	●	●	●	●	●	●	●	●	●	●	●	●	●	●	●	●	●	● ●	Yellow Glow
●	●	●	●	●	●	●	●	●	●	●	●	●	●	●	●	●	●	●	●	● ●	Rustic Brown
●	●	●	●	●	●	●	●	●	●	●	●	●	●	●	●	●	●	●	●	● ●	Classic Red
<b>ENAMEL COLORS</b>																					
●	●	●	●	●	●	●	●	●	●	●	●	●	●	●	●	●	●	●	●	● ●	Glacier White
●	●	●	●	●	●	●	●	●	●	●	●	●	●	●	●	●	●	●	●	● ●	Polar White
●	●	●	●	●	●	●	●	●	●	●	●	●	●	●	●	●	●	●	●	● ●	Almond Cream
●	●	●	●	●	●	●	●	●	●	●	●	●	●	●	●	●	●	●	●	● ●	Adobe Cream
●	●	●	●	●	●	●	●	●	●	●	●	●	●	●	●	●	●	●	●	● ●	Antique Parchment
●	●	●	●	●	●	●	●	●	●	●	●	●	●	●	●	●	●	●	●	● ●	Desert Tone
●	●	●	●	●	●	●	●	●	●	●	●	●	●	●	●	●	●	●	●	● ●	Wickertone
●	●	●	●	●	●	●	●	●	●	●	●	●	●	●	●	●	●	●	●	● ●	Sandtone
●	●	●	●	●	●	●	●	●	●	●	●	●	●	●	●	●	●	●	●	● ●	Autumn Beige
●	●	●	●	●	●	●	●	●	●	●	●	●	●	●	●	●	●	●	●	● ●	Claytone
●	●	●	●	●	●	●	●	●	●	●	●	●	●	●	●	●	●	●	●	● ●	T-Tone
●	●	●	●	●	●	●	●	●	●	●	●	●	●	●	●	●	●	●	●	● ●	Pewter
●	●	●	●	●	●	●	●	●	●	●	●	●	●	●	●	●	●	●	●	● ●	Heritage Gray
●	●	●	●	●	●	●	●	●	●	●	●	●	●	●	●	●	●	●	●	● ●	Classic Blue
●	●	●	●	●	●	●	●	●	●	●	●	●	●	●	●	●	●	●	●	● ●	Hartford Green
●	●	●	●	●	●	●	●	●	●	●	●	●	●	●	●	●	●	●	●	● ●	Royal Brown
●	●	●	●	●	●	●	●	●	●	●	●	●	●	●	●	●	●	●	●	● ●	Statuary Bronze

# Table of Contents

---

**Steel-kore® Steel Siding** .....page 4  
 Double 4" PVC, Double 4" Entex, Double 5" Dutchlap, 8" PVC, 8" Entex

**Steel Siding and Accessories** ..... pages 5-6  
 Double 6", 12" Board and Batten Vertical, Corner Post Cap, Corner Substrate, Corner Cap, J-Channel, Undersill Trim, Starter Strip, Frieze Trim, Siding Nails

**Steel-kore® Steel Siding Specifications** .....page 7

**aluma-kore® Quad Soffit System** .....page 8  
 Plain, Center Vent, Full Vent, Pre-Cut Panels

**aluma-kore® Quad Soffit Accessories** ..... page 9-10  
 F-Channel, 7/16" J-Channel, Drip Edge, 1-1/4" Wide Face J-Channel, Fascia Corner, Frieze Trim, Mitre Moulding

**Fascia** .....page 11  
 Steel Wood-Grained Fascia Cover

**Trim Coil** .....page 12  
 24" Steel, 15" Steel, 18" Aluminum, 24" Aluminum

**Soffit & Fascia Specifications** .....page 13

**ArrowLine Shingle-Shake, Slate & Accessories** ..... page 14-16  
 12" Shingle-Shake, 12" Slate, Eave Starter, Rake Starter, J-Trim, End Wall Starter, End Wall Cap, Valley Cap, Valley Flashing, TrimLine Vent, 12" Ridge/Hip Cap, Starter Base, Sub Seal, Trim Coil, Shingle Clip, Valley Clip, Touch-Up Paint, Foam Seal, Wind & Water Seal

**ArrowLine Shingle-Shake & Slate Specifications** .....page 17

**Rainware & Accessories** ..... pages 18-23  
 Gutters, Gutter Guard, Downspouts, A & B Elbows, Downspout U-Band, Downspout Pipe Band, End Caps, Outside Corner Mitre, Inside Corner Mitre, Outside Strip Mitre, Inside Strip Mitre, Slip Joint Connector, Gutter Apron, Drop Outlet, Gutter Coil, Combo Fascia Hanger, Sampson Hanger, Heavy Duty Roof Hanger, Combo Strap, Spike, Ferrule, Vampire Hanger, Vampire Tool

**Rainware Specifications** .....page 24

**Casing Sills & Trim** .....page 25  
 Sill Cover, Drip Cap, Adjustable Drip Cap, Flat Casing Cover, Brick Casing Cover

**Sealant, Paint, & Nails** .....pages 26  
 Quad Formula Sealant, Touch-Up Paint, Spray Paint, Ring-Shank Nails, Galvanized Trim Nails, Zip Screws, Pop-Rivet

# Steel•Kore® Steel Siding

## Double 4" Clapboard Siding

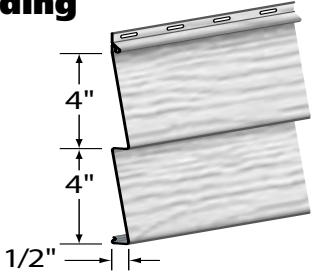

Product Code: 1056-\_\_\_  
 Finish: PVC  
 Exposure: 8"  
 Length: 12' 6"  
 Thickness: 29 gauge  
 Texture: Timber Grain  
 Projection: 1/2"  
 Panels/Ctn: 12  
 Coverage: 100 sq ft/ctn  
 Lbs/Ctn: 95 lbs

109-Claytone	120-Colonial White	126-Driftwood Gray
114-Glacier White	121-Sand Beige	127-Classic Red
115-Antique Parchment	122-Rustic Brown	128-Charcoal Gray
117-Wickertone	123-Spring Green	129-Yellow Glow
118-Desert Tone	125-Slate Blue	133-Heritage Blue

## Double 4" Clapboard Siding

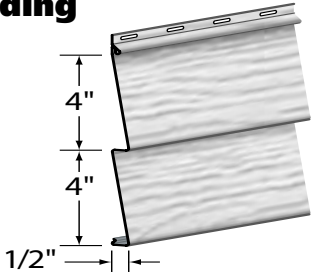

Product Code: 1056-\_\_\_  
 Finish: Entex  
 Exposure: 8"  
 Length: 12' 6"  
 Thickness: 29 gauge  
 Texture: Select Emboss  
 Projection: 1/2"  
 Panels/Ctn: 12  
 Coverage: 100 sq ft/ctn  
 Lbs/Ctn: 95 lbs

### Entex

707-Classic Blue	718-Desert Tone	786-Canyon
708-T-tone	728-Charcoal Gray	792-Willow
712-Sandtone	732-Cedar	
714-Glacier White	785-Mahogany	

## Double 5" Dutchlap Siding

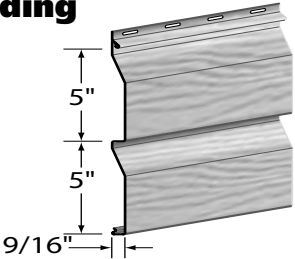

Product Code: 1049-\_\_\_  
 Finish: PVC  
 Exposure: 10"  
 Length: 12' 0"  
 Thickness: 29 gauge  
 Texture: Timber Grain  
 Projection: 9/16"  
 Panels/Ctn: 10  
 Coverage: 100 sq ft/ctn  
 Lbs/Ctn: 92 lbs

109-Claytone	120-Colonial White	126-Driftwood Gray
114-Glacier White	121-Sand Beige	127-Classic Red
115-Antique Parchment	122-Rustic Brown	128-Charcoal Gray
117-Wickertone	123-Spring Green	129-Yellow Glow
118-Desert Tone	125-Slate Blue	133-Heritage Blue

## 8" Clapboard Siding

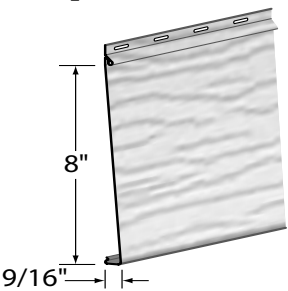

Product Code: 1051-\_\_\_  
 Finish: PVC  
 Exposure: 8"  
 Length: 12' 6"  
 Thickness: 29 gauge  
 Texture: Timber Grain  
 Projection: 9/16"  
 Panels/Ctn: 12  
 Coverage: 100 sq ft/ctn  
 Lbs/Ctn: 99 lbs

109-Claytone	120-Colonial White	126-Driftwood Gray
114-Glacier White	121-Sand Beige	127-Classic Red
115-Antique Parchment	122-Rustic Brown	128-Charcoal Gray
117-Wickertone	123-Spring Green	129-Yellow Glow
118-Desert Tone	125-Slate Blue	133-Heritage Blue

## 8" Clapboard Siding

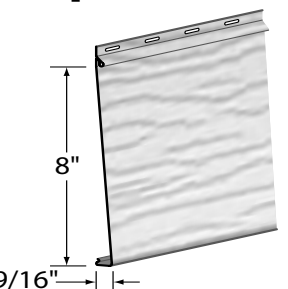

Product Code: 1051-\_\_\_  
 Finish: Entex  
 Exposure: 8"  
 Length: 12' 6"  
 Thickness: 29 gauge  
 Texture: Select Emboss  
 Projection: 9/16"  
 Panels/Ctn: 12  
 Coverage: 100 sq ft/ctn  
 Lbs/Ctn: 99 lbs

### Entex

707-Classic Blue	718-Desert Tone	786-Canyon
708-T-tone	728-Charcoal Gray	792-Willow
712-Sandtone	732-Cedar	
714-Glacier White	785-Mahogany	

# Steel•Kore® Steel Siding Accessories

## Double 6" Clapboard Siding

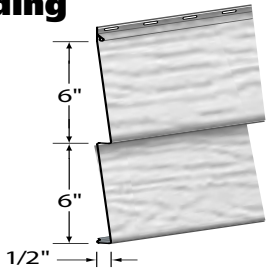

Product Code: 1046-\_\_\_  
 Finish: PVC  
 Exposure: 12"  
 Length: 12' 6"  
 Thickness: 29 gauge  
 Texture: Timber Grain  
 Projection: 1/2"  
 Panels/Ctn: 8  
 Coverage: 100 sq ft/ctn  
 Lbs/Ctn: 92 lbs

109-Claytone	120-Colonial White	126-Driftwood Gray
114-Glacier White	121-Sand Beige	127-Classic Red
115-Antique Parchment	122-Rustic Brown	128-Charcoal Gray
117-Wickertone	123-Spring Green	129-Yellow Glow
118-Desert Tone	125-Slate Blue	133-Heritage Blue

## 12" Vertical Siding

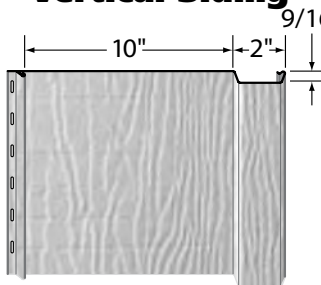

Product Code: 1052-\_\_\_  
 Finish: PVC  
 Exposure: 12"  
 Length: 10' 0"  
 Thickness: 29 gauge  
 Texture: Timber Grain  
 Projection: 9/16"  
 Panels/Ctn: 10  
 Coverage: 100 sq ft/ctn  
 Lbs/Ctn: 92 lbs

109-Claytone	120-Colonial White	126-Driftwood Gray
114-Glacier White	121-Sand Beige	127-Classic Red
115-Antique Parchment	122-Rustic Brown	128-Charcoal Gray
117-Wickertone	123-Spring Green	129-Yellow Glow
118-Desert Tone	125-Slate Blue	133-Heritage Blue

## Snap-On Outside Corner Post Cap

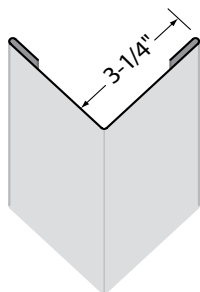

Product Code: 1068-\_\_\_  
 Finish: PVC/Entex  
 Length: 12'  
 Thickness: 29 gauge  
 Pieces/Ctn: 10  
 Lbs/Ctn: 72 lbs

### PVC Colors

109-Claytone	121-Sand Beige	128-Charcoal Gray
114-Glacier White	122-Rustic Brown	129-Yellow Glow
115-Antique Parchment	123-Spring Green	133-Heritage Blue
117-Wickertone	125-Slate Blue	134-Sherwood Green
118-Desert Tone	126-Driftwood Gray	
120-Colonial White	127-Classic Red	

### Entex Colors

707-Classic Blue	718-Desert Tone	786-Canyon
708-T-tone	728-Charcoal Gray	792-Willow
712-Sandtone	732-Cedar	
714-Glacier White	785-Mahogany	

## Snap-On Corner Substrate

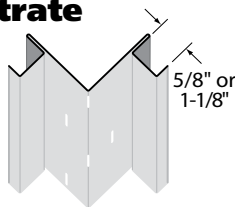

Product Code:  
 5/8" Hollow-Back: 1069-000  
 1-1/8" Insulated: 1070-000  
 Length: 12'  
 Thickness: 29 gauge  
 Pieces/Ctn: 10  
 Lbs/Ctn: 48 lbs

## J-Channel

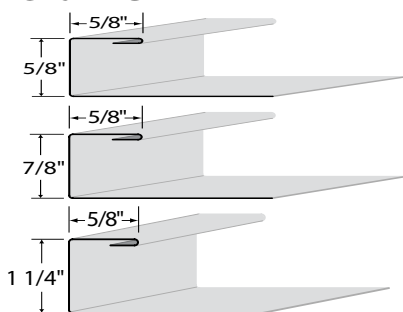

Product Code:  
 5/8": 1061-\_\_\_  
 7/8": 1059-\_\_\_  
 1-1/4": 1060-\_\_\_  
 Finish: PVC / Entex  
 Length: 12'  
 Thickness: 29 gauge  
 Pieces/Ctn: 25  
 Lbs/Ctn: 50 lbs

### PVC Colors

109-Claytone	121-Sand Beige	128-Charcoal Gray
114-Glacier White	122-Rustic Brown	129-Yellow Glow
115-Antique Parchment	123-Spring Green	133-Heritage Blue
117-Wickertone	125-Slate Blue	134-Sherwood Green
118-Desert Tone	126-Driftwood Gray	
120-Colonial White	127-Classic Red	

### Entex Colors

707-Classic Blue	718-Desert Tone	786-Canyon
708-T-tone	728-Charcoal Gray	792-Willow
712-Sandtone	732-Cedar	
714-Glacier White	785-Mahogany	

# Steel•Kore® Steel Siding Accessories

## Snap-On Frieze Trim

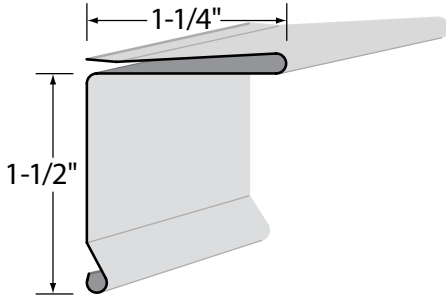

Product Code: 1072-\_\_\_\_  
 Finish: Enamel/PVC  
 Entex  
 Thickness: 29 gauge  
 Length: 12'  
 Pieces/Ctn: 25  
 Lbs/Ctn: 75 lbs

## Enamel

001-Polar White	007-Classic Blue	012-Sandtone
003-Royal Brown	008-T-Tone	013-Statuary Bronze
004-Adobe Cream	009-Claytone	014-Glacier White
005-Autumn Beige	010-Heritage Gray	015-Antique Parchment

## PVC

109-Claytone	121-Sand Beige	128-Charcoal Gray
114-Glacier White	122-Rustic Brown	129-Yellow Glow
115-Antique Parchment	123-Spring Green	133-Heritage Blue
117-Wickertone	125-Slate Blue	134-Sherwood Green
118-Desert Tone	126-Driftwood Gray	
120-Colonial White	127-Classic Red	

## Entex

707-Classic Blue	718-Desert Tone	786-Canyon
708-T-tone	728-Charcoal Gray	792-Willow
712-Sandtone	732-Cedar	
714-Glacier White	785-Mahogany	

## Undersill Trim

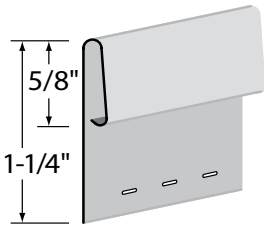

Product Code: 1062-\_\_\_\_  
 Finish: PVC / Entex  
 Length: 12'  
 Thickness: 29 gauge  
 Pieces/Ctn: 25  
 Lbs/Ctn: 45 lbs

## PVC

109-Claytone	121-Sand Beige	128-Charcoal Gray
114-Glacier White	122-Rustic Brown	129-Yellow Glow
115-Antique Parchment	123-Spring Green	133-Heritage Blue
117-Wickertone	125-Slate Blue	134-Sherwood Green
118-Desert Tone	126-Driftwood Gray	
120-Colonial White	127-Classic Red	

## Entex

707-Classic Blue	718-Desert Tone	786-Canyon
708-T-tone	728-Charcoal Gray	792-Willow
712-Sandtone	732-Cedar	
714-Glacier White	785-Mahogany	

## Starter Strip

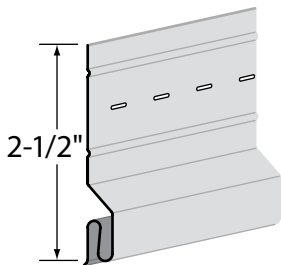

Product Code: 1063-000  
 Finish: None  
 Length: 10'  
 Thickness: 29 gauge  
 Pieces/Ctn: 20  
 Lbs/Ctn: 45 lbs

## Spring-Lok Wide Starter Strip

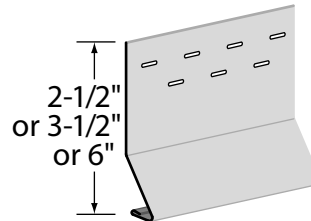

Product Code:  
 2-1/2" Wide: 1066-000  
 3-1/2" Wide: 1065-000  
 6" Wide: 1064-000  
 Finish: None  
 Length: 10'  
 Thickness: 29 gauge  
 Pieces/Ctn: 20  
 Lbs/Ctn:  
 2 1/2" 30 lbs  
 3 1/2" 43 lbs  
 6" 73 lbs

## Double Hot-Dipped Galvanized Steel Siding Nails



Product Code:  
 2" (5 lb box) : 3417-000  
 2-1/2" (5 lb box) : 3419-000  
 3" (5 lb box) : 3421-000  
 2" (50 lb box) : 3418-000  
 2-1/2" (50# box) : 3420-000

## Grip-Rite Electro-Galvanized Steel & Vinyl Siding Nail



Product Code:  
 2": 3427-000  
 Lbs/Ctn: 50 lb

# Steel•Kore® Steel Siding Specifications

## PRODUCT SPECIFICATIONS FOR PVC AND ENTEx® STEEL-KORE® STEEL SIDING SYSTEM

### General Characteristics

EDCO Steel-Kore® steel siding is intended for sidewall installation on residential or commercial exterior applications in new construction or remodeling with or without sheathing type or drop in insulation or underlayment. Siding to be manufactured with Timber Grained embossed finish.

### Material Specifications - Metal

EDCO Steel-Kore® steel siding and steel siding accessories shall be coated with a PVC Plastisol or Entex® finish and made with L.F.Q. steel of the specified color and texture fabricated from nominal 29 gauge galvanized steel coil, with both sides zinc-coated by the continuous hot dipped galvanizing method.

Tensile Strength (PSI) . . . 50,000

Yield Strength (PSI) 35,000

All material conforms to ASTM A653/A653M-50

- A.) Clapboards shall provide Double 4", Double 5" Dutchlap, Double 6" and 8" exposure and shall be furnished in lengths calculated to total 100 square feet exposed area per carton. The product shall be formed at the factory with a nailing flange to interlock securely with successive courses.
- B.) Vertical siding to be formed at the factory with a board and batten appearance having a batten width of approximately 2" and standard widths of 12" calculated to a total 100 sq. feet of exposure area per carton.

### Material Specifications - Paint

EDCO Steel-Kore® steel siding shall be in accordance with Edco manufacturing specifications including:

- Paint preparation: Both sides chemically cleaned with an Alkaline "Parco 338W" cleaner.  
Dry in place chrome conversion coating with Henkel "Bonderite 1402W" applied to both sides.
- PVC Paint System: Prime Coat - Akzo - Nobel Coating's Prime-A-Sol corrosion resistant primer.  
Top Coat - Akzo - Nobel Coating's chemical striated vinyl Plastisol, average film thickness 4.0 mil.  
Back Coat - Akzo - Nobel Coating's corrosion resisting backer.
- Entex Paint System: Prime Coat - DuraCoat's DURAdhesion corrosion resistant Global Primer  
Top Coat - DuraCoat's XT-40S with DuraCool pigments, average thickness 1.0 mil  
Back Coat - Akzo - Nobel Coating's corrosion resisting backer.

### Manufacturing

- Panel:
- A.) 8" exposure x 12'6" long, 5/8" butt.
  - B.) Double 4" exposure x 12'6" long, 9/16" butt.
  - C.) Double 5" Dutchlap exposure 12'0" long, 1/2" butt.
  - D.) Double 6" exposure x 12'6" long, 1/2" butt.
  - E.) Vertical 12" exposure x 10'0" long, 1/2" batten butt.
- Packed:
- D4" and 8" - 12 pcs. (100 sq. ft.) per carton.
  - D5" Dutchlap - 10 pcs. (100 sq. ft.) per carton.
  - D6" - 8 pcs. (100 sq. ft.) per carton
  - Vertical - 10 pcs. (100 sq. ft.) per carton.

All accessories shall be color matched to be visually similar in all respects to the color of the steel siding or panel unless otherwise specified. Manufacturer's warranty is not valid unless EDCO Steel-Kore® siding accessories, where applicable to the job, are used.

### Warranty

EDCO shall provide a Lifetime Non prorated Limited Warranty (50 year transferred), 50 year Limited Hail Protection (materials only) and 10 year Fade Protection (not to exceed 5 Delta E units).

EDCO Steel-Kore® siding conforms to current FHA requirements and meets specifications of BOCA, ICBO and SBCC.

Custom lengths up to 144" in  
Plain, Center Vent, and Full Vent

1468-000 (Enamel) / 1468-100 (PVC)

Call for lead times.

# aluma-kore® Soffit System

## Plain Quad Soffit

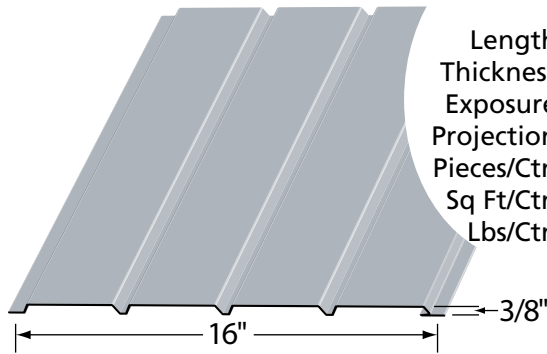

Product Code: 1470-\_\_\_\_  
Finish: Enamel/PVC  
Entex  
Length: 12'  
Thickness: .019"  
Exposure: 16"  
Projection: 3/8"  
Pieces/Ctn: 12  
Sq Ft/Ctn: 192 sq ft  
Lbs/Ctn: 65 lbs

## Enamel

- |                    |                     |                       |
|--------------------|---------------------|-----------------------|
| 001-Polar White    | 007-Classic Blue    | 014-Glacier White     |
| 002-Almond Cream   | 008-T-Tone          | 015-Antique Parchment |
| 003-Royal Brown    | 009-Claytone        | 016-Pewter            |
| 004-Adobe Cream    | 010-Heritage Gray   | 017-Wickertone        |
| 005-Autumn Beige   | 012-Sandtone        | 018-Desert Tone       |
| 006-Hartford Green | 013-Statuary Bronze |                       |

## PVC

- |                       |                    |                    |
|-----------------------|--------------------|--------------------|
| 109-Claytone          | 120-Colonial White | 127-Classic Red    |
| 114-Glacier White     | 121-Sand Beige     | 128-Charcoal Gray  |
| 115-Antique Parchment | 122-Rustic Brown   | 133-Heritage Blue  |
| 117-Wickertone        | 125-Slate Blue     | 134-Sherwood Green |
| 118-Desert Tone       | 126-Driftwood Gray |                    |

## Center Vent Quad Soffit

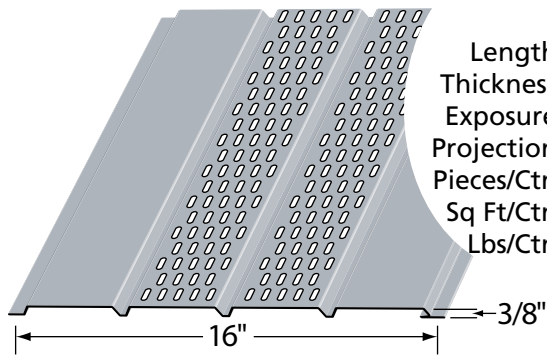

Product Code: 1474-\_\_\_\_  
Finish: Enamel/PVC  
Entex  
Length: 12'  
Thickness: .019"  
Exposure: 16"  
Projection: 3/8"  
Pieces/Ctn: 12  
Sq Ft/Ctn: 192 sq ft  
Lbs/Ctn: 65 lbs

## Entex

- |                   |                   |            |
|-------------------|-------------------|------------|
| 707-Classic Blue  | 718-Desert Tone   | 786-Canyon |
| 708-T-tone        | 728-Charcoal Gray | 792-Willow |
| 712-Sandtone      | 732-Cedar         |            |
| 714-Glacier White | 785-Mahogany      |            |

## Full Vent Quad Soffit

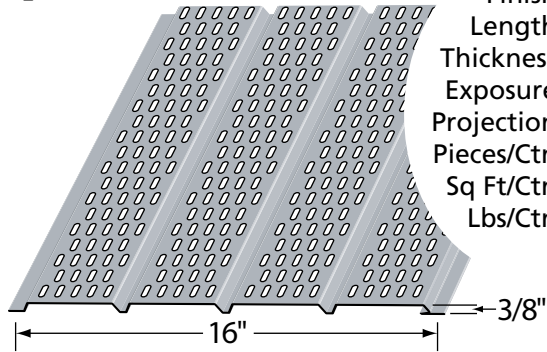

Product Code: 1478-\_\_\_\_  
Finish: Enamel/PVC  
Length: 12'  
Thickness: .019"  
Exposure: 16"  
Projection: 3/8"  
Pieces/Ctn: 12  
Sq Ft/Ctn: 192 sq ft  
Lbs/Ctn: 65 lbs

## Enamel

- |                    |                     |                                      |
|--------------------|---------------------|--------------------------------------|
| 001-Polar White    | 008-T-Tone          | (All other colors are special order) |
| 002-Almond Cream   | 012-Sandtone        |                                      |
| 003-Royal Brown    | 013-Statuary Bronze |                                      |
| 006-Hartford Green | 014-Glacier White   |                                      |

## PVC

- |                       |                    |                    |
|-----------------------|--------------------|--------------------|
| 109-Claytone          | 120-Colonial White | 127-Classic Red    |
| 114-Glacier White     | 121-Sand Beige     | 128-Charcoal Gray  |
| 115-Antique Parchment | 122-Rustic Brown   | 133-Heritage Blue  |
| 117-Wickertone        | 125-Slate Blue     | 134-Sherwood Green |
| 118-Desert Tone       | 126-Driftwood Gray |                    |

## Pre-Cut Panels

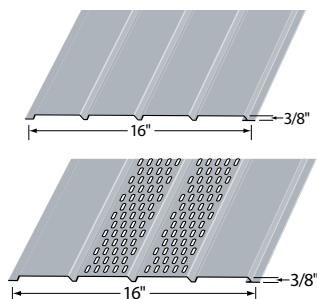

Product Code:  
Plain 12": 1471-\_\_\_\_  
Plain 24": 1472-\_\_\_\_  
Center Vent 12": 1475-\_\_\_\_  
Center Vent 24": 1476-\_\_\_\_  
Finish: Enamel  
Thickness: .019"  
Exposure: 16"  
Pieces/Ctn: 30  
Running Ft/Ctn: 40 ft  
Lbs/Ctn: 13 / 25 lbs

## Enamel

- |                  |                 |                   |
|------------------|-----------------|-------------------|
| 001-Polar White  | 003-Royal Brown | 012-Sandtone      |
| 002-Almond Cream | 008-T-Tone      | 014-Glacier White |



# aluma-kore® Soffit Accessories

## F - Channel

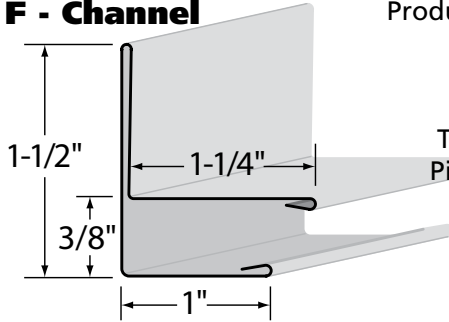

Product Code: 1191-\_\_\_  
 Finish: Enamel/PVC  
 Entex  
 Length: 12'  
 Thickness: .019"  
 Pieces/Ctn: 25  
 Lbs/Ctn: 30 lbs

## Enamel

- |                    |                     |                       |
|--------------------|---------------------|-----------------------|
| 001-Polar White    | 007-Classic Blue    | 014-Glacier White     |
| 002-Almond Cream   | 008-T-Tone          | 015-Antique Parchment |
| 003-Royal Brown    | 009-Claytone        | 016-Pewter            |
| 004-Adobe Cream    | 010-Heritage Gray   | 017-Wickertone        |
| 005-Autumn Beige   | 012-Sandtone        | 018-Desert Tone       |
| 006-Hartford Green | 013-Statuary Bronze |                       |

## J - Channel: 7/16"

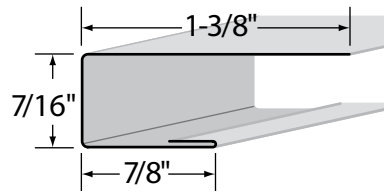

Product Code: 1028-\_\_\_  
 Finish: Enamel/PVC  
 Entex  
 Length: 12'  
 Thickness: .019"  
 Pieces/Ctn: 25  
 Lbs/Ctn: 19 lbs

## PVC

- |                       |                    |                    |
|-----------------------|--------------------|--------------------|
| 109-Claytone          | 120-Colonial White | 127-Classic Red    |
| 114-Glacier White     | 121-Sand Beige     | 128-Charcoal Gray  |
| 115-Antique Parchment | 122-Rustic Brown   | 133-Heritage Blue  |
| 117-Wickertone        | 125-Slate Blue     | 134-Sherwood Green |
| 118-Desert Tone       | 126-Driftwood Gray |                    |

## Entex

- |                   |                   |            |
|-------------------|-------------------|------------|
| 707-Classic Blue  | 718-Desert Tone   | 786-Canyon |
| 708-T-tone        | 728-Charcoal Gray | 792-Willow |
| 712-Sandtone      | 732-Cedar         |            |
| 714-Glacier White | 785-Mahogany      |            |

## Roof Drip Edge: QuickStart

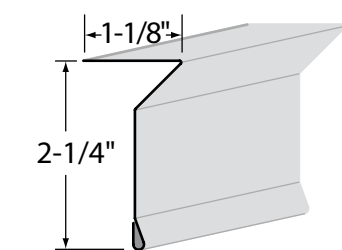

Product Code:  
 Enamel: 1179-\_\_\_  
 PVC / Entex: 1178-\_\_\_  
 Finish: Enamel/PVC  
 Entex  
 Length: 12'  
 Thickness: 29 gauge  
 Pieces/Ctn: 25  
 Lbs/Ctn: 30 lbs

## Roof Drip Edge: Style D

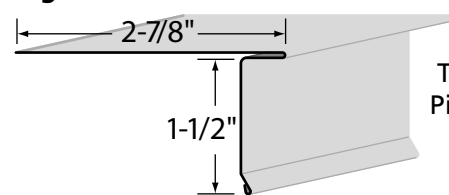

Product Code: 1177-\_\_\_  
 Finish: Enamel/PVC  
 Entex  
 Length: 10'  
 Thickness: 29 gauge  
 Pieces/Ctn: 25  
 Lbs/Ctn: 70 lbs

## Wide Face J-Channel 1-1/4"

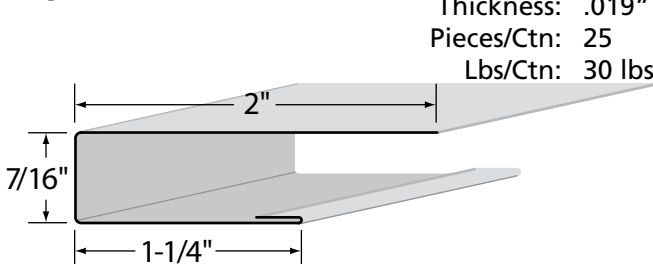

Product Code: 1029-\_\_\_  
 Finish: Enamel/PVC  
 Length: 12'  
 Thickness: .019"  
 Pieces/Ctn: 25  
 Lbs/Ctn: 30 lbs

## Enamel

- |                 |                   |
|-----------------|-------------------|
| 001-Polar White | 014-Glacier White |
|-----------------|-------------------|

## PVC

- |                   |                    |
|-------------------|--------------------|
| 114-Glacier White | 120-Colonial White |
|-------------------|--------------------|

# aluma-kore® Soffit Accessories

## Fascia Corner

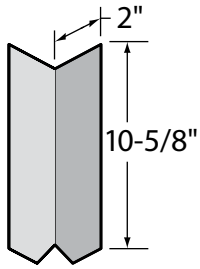

Product Code: 1188-\_\_\_\_  
 Smooth: 1188-\_\_\_\_  
 Woodgrain: 1189-\_\_\_\_  
 Finish: Enamel/PVC  
 Length: 10-5/8"  
 Thickness: .024"  
 Pieces/Ctn: 25  
 Lbs/Ctn: 2 lbs

## Woodgrained

001-Polar White	007-Classic Blue	013-Statuary Bronze
002-Almond Cream	008-T-Tone	014-Glacier White
003-Royal Brown	009-Claytone	015-Antique Parchment
004-Adobe Cream	010-Heritage Gray	
005-Autumn Beige	012-Sandtone	

## Smooth

001-Polar White	014-Glacier White	120-Colonial White
-----------------	-------------------	--------------------

## Snap-On Frieze Trim

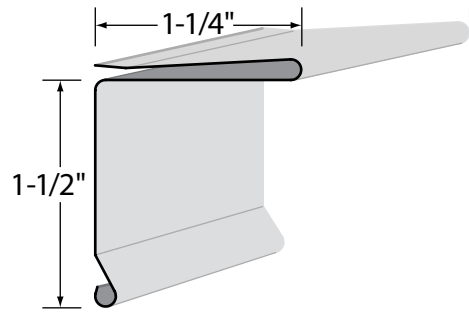

Product Code: 1072-\_\_\_\_  
 Finish: Enamel/PVC  
 Entex  
 Length: 12'  
 Thickness: 29 gauge  
 Pieces/Ctn: 25  
 Lbs/Ctn: 75 lbs

## Enamel

001-Polar White	007-Classic Blue	012-Sandtone
003-Royal Brown	008-T-Tone	013-Statuary Bronze
004-Adobe Cream	009-Claytone	014-Glacier White
005-Autumn Beige	010-Heritage Gray	015-Antique Parchment

## PVC

109-Claytone	121-Sand Beige	128-Charcoal Gray
114-Glacier White	122-Rustic Brown	129-Yellow Glow
115-Antique Parchment	123-Spring Green	133-Heritage Blue
117-Wickertone	125-Slate Blue	134-Sherwood Green
118-Desert Tone	126-Driftwood Gray	
120-Colonial White	127-Classic Red	

## Entex

707-Classic Blue	718-Desert Tone	786-Canyon
708-T-tone	728-Charcoal Gray	792-Willow
712-Sandtone	732-Cedar	
714-Glacier White	785-Mahogany	

## Roof Drip Edge: NS

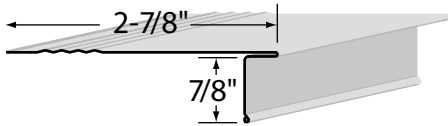

Product Code: 1181-\_\_\_\_  
 Finish: Enamel  
 Length: 12'  
 Thickness: .019"  
 Pieces/Ctn: 25  
 Lbs/Ctn: 30 lbs

## Enamel

001-Polar White	008-T-Tone	014-Glacier White
002-Almond Cream	012-Sandtone	
003-Royal Brown	013-Statuary Bronze	

## Mitre Moulding

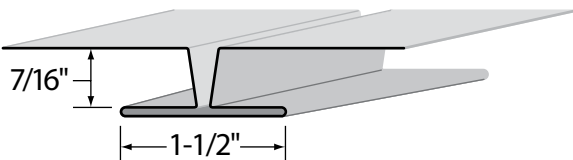

Product Code: 1200-\_\_\_\_  
 Finish: Enamel  
 Length: 12'  
 Thickness: .019"  
 Pieces/Ctn: 15  
 Lbs/Ctn: 20 lbs

## Enamel

001-Polar White	008-T-Tone	014-Glacier White
003-Royal Brown	012-Sandtone	

# Fascia System

## Steel Fascia Cover Woodgrain (Enamel)

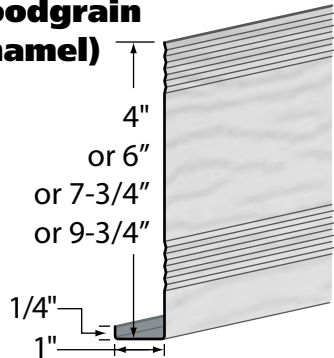

Product Code:  
 4": 1194-001  
 6": 1192-\_\_\_\_  
 nominal 8": 1198-\_\_\_\_  
 nominal 10": 1195-\_\_\_\_  
 Finish: Enamel  
 Texture: Woodgrain  
 Length: 10'  
 Thickness: 29 gauge  
 Pieces/Ctn: 20/20/20/12  
 Lbs/Ctn: 60/80/  
 100/75 lbs

## Enamel

001-Polar White	007-Classic Blue	014-Glacier White
002-Almond Cream	008-T-Tone	015-Antique Parchment
003-Royal Brown	009-Claytone	016-Pewter
004-Adobe Cream	010-Heritage Gray	017-Wickertone
005-Autumn Beige	012-Sandtone	018-Desert Tone
006-Hartford Green	013-Statuary Bronze	

*4" only available in 001-Polar White*

## Steel Fascia Cover Woodgrain (PVC)

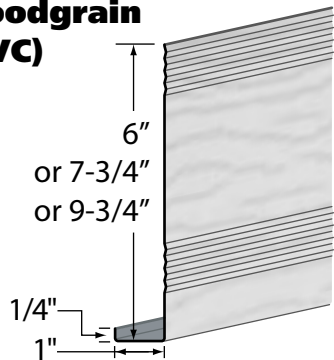

Product Code:  
 6": 1192-\_\_\_\_  
 nominal 8": 1198-\_\_\_\_  
 nominal 10": 1195-\_\_\_\_  
 Finish: PVC  
 Texture: Woodgrain  
 Length: 10'  
 Thickness: 29 gauge  
 Pieces/Ctn: 20/20/12  
 Lbs/Ctn: 90/100/  
 80 lbs

## PVC

109-Claytone	120-Colonial White	127-Classic Red
114-Glacier White	121-Sand Beige	128-Charcoal Gray
115-Antique Parchment	122-Rustic Brown	130-Claytone
117-Wickertone	125-Slate Blue	133-Heritage Blue
118-Desert Tone	126-Driftwood Gray	134-Sherwood Green

## Steel Fascia Cover Woodgrain (Entex)

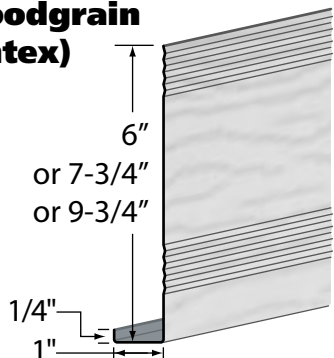

Product Code:  
 6": 1192-\_\_\_\_  
 nominal 8": 1198-\_\_\_\_  
 nominal 10": 1195-\_\_\_\_  
 Finish: Entex  
 Texture: Woodgrain  
 Length: 10'  
 Thickness: 29 gauge  
 Pieces/Ctn: 20/20/12  
 Lbs/Ctn: 90/100/  
 80 lbs

## Entex

707-Classic Blue	718-Desert Tone	786-Canyon
708-T-tone	728-Charcoal Gray	792-Willow
712-Sandtone	732-Cedar	
714-Glacier White	785-Mahogany	

# Trim Coil

## Steel Trim Coil 24" x 50'

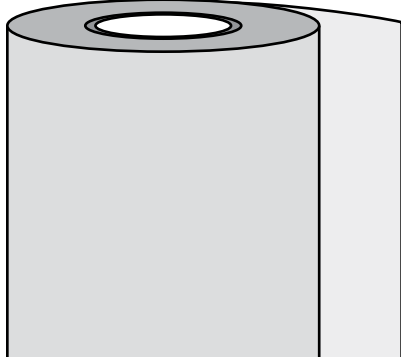

Product Code: 1363-\_\_\_  
 Finish: Enamel/PVC  
 Entex  
 Width: 24"  
 Length: 50'  
 Thickness: 30 gauge  
 Lbs: 54 lbs

### Enamel

001-Polar White	007-Classic Blue	014-Glacier White
002-Almond Cream	008-T-Tone	015-Antique Parchment
003-Royal Brown	009-Claytone	016-Pewter
004-Adobe Cream	010-Heritage Gray	017-Wickertone
005-Autumn Beige	012-Sandtone	018-Desert Tone
006-Hartford Green	013-Statuary Bronze	

### PVC

109-Claytone	120-Colonial White	128-Charcoal Gray
114-Glacier White	121-Sand Beige	133-Heritage Blue
115-Antique Parchment	122-Rustic Brown	134-Sherwood Green
117-Wickertone	126-Driftwood Gray	
118-Desert Tone	127-Classic Red	

### Entex

707-Classic Blue	718-Desert Tone	786-Canyon
708-T-tone	728-Charcoal Gray	792-Willow
712-Sandtone	732-Cedar	
714-Glacier White	785-Mahogany	

## Steel Trim Coil 15" x 50'

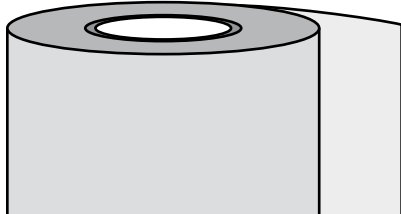

Product Code: 1374-\_\_\_  
 Finish: PVC  
 Width: 15"  
 Length: 50'  
 Thickness: 29 gauge  
 Lbs: 42 lbs

### PVC

123-Spring Green	125-Slate Blue	129-Yellow Glow
------------------	----------------	-----------------

## Aluminum Trim Coil 18" x 50'

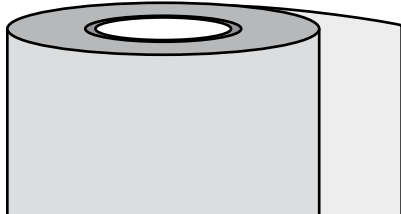

Product Code: 1371-\_\_\_  
 Finish: PVC  
 Width: 18"  
 Length: 50'  
 Thickness: .019"  
 Lbs: 21 lbs

### PVC

109-Claytone	121-Sand Beige	128-Charcoal Gray
114-Glacier White	122-Rustic Brown	129-Yellow Glow
115-Antique Parchment	123-Spring Green	133-Heritage Blue
117-Wickertone	125-Slate Blue	134-Sherwood Green
118-Desert Tone	126-Driftwood Gray	
120-Colonial White	127-Classic Red	

Product Code: 1372-120  
 18" X 100' Col. White Only

## Aluminum Trim Coil 24" x 50'

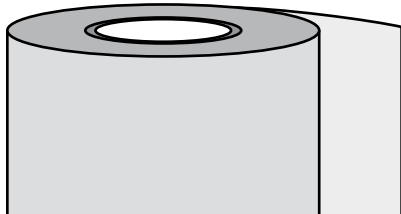

Product Code: 1373-\_\_\_  
 Finish: Enamel/PVC  
 Entex  
 Width: 24"  
 Length: 50'  
 Thickness: .019"  
 Lbs: 29/30 lbs

### Enamel — Polar White on reverse side

001-Polar White	007-Classic Blue	014-Glacier White
002-Almond Cream	008-T-Tone	015-Antique Parchment
003-Royal Brown	009-Claytone	016-Pewter
004-Adobe Cream	010-Heritage Gray	017-Wickertone
005-Autumn Beige	012-Sandtone	018-Desert Tone
006-Hartford Green	013-Statuary Bronze	

### PVC

114-Glacier White	120-Colonial White
-------------------	--------------------

### Entex

707-Classic Blue	718-Desert Tone	786-Canyon
708-T-tone	728-Charcoal Gray	792-Willow
712-Sandtone	732-Cedar	
714-Glacier White	785-Mahogany	

# Quad Soffit & Fascia Specifications

## ALUMA-KORE® ALUMINUM QUAD SOFFIT AND STEEL-KORE STEEL FASCIA (Available in Enamel, Entex and PVC Finishes)

### General Characteristics

EDCO Aluma-Kore® Aluminum Quad soffit system is intended for exterior overhang installations on residential or commercial buildings.

### Material Specifications

Soffit - Metal	Nominal .019" thick aluminum, alloy 3105, hardness/temper H-15	
Fascia - Steel	Nominal 29 gauge galvanized steel, Zinc coated by the continuous hot dipped galvanizing method. Conforms to ASTM A653/A653M-05	
Aluminum Tensile Strength (PSI): . . . . .	26,000 <sup>1</sup>	Aluminum Yield Strength (PSI): . . . . .25,000 <sup>1</sup>
Aluminum Ult Sheer Strength (PSI): . . .	15,000 <sup>1</sup>	Aluminum Endurance Limit (PSI): . . .10,000 <sup>1</sup>
Steel Tensile Strength (PSI):. . . . .	50,000 <sup>1</sup>	Steel Yield Strength (PSI):. . . . .35,000 <sup>1</sup>

### Material Paint Specifications

Paint Preparation:	Both sides of substrate chemically cleaned with an alkaline "Parco 338W" cleaner. Dry in place chrome conversion coating with Henkel "1402W Bonderite" applied to both sides of substrate.
Enamel Paint System:	Top Coat - Valspar "Ultra-Flex" thermo setting polyester system. Back Coat - Polyester corrosion resisting coating.
PVC Paint System:	Prime Coat - Akzo - Nobel Coating's "Prime-A-Sol" corrosion resistant primer. Top Coat - Akzo - Nobel Coating's chemical striated vinyl plastisol, applied 4 mil. thick system. Back Coat - Akzo - Nobel Coating's corrosion resisting backer
Entex Paint System:	Prime Coat - DuraCoat's DURAdhesion corrosion resistant Global Primer Top Coat - DuraCoat's XT-40S with DuraCool pigments, average thickness 1.0 mil Back Coat - Akzo - Nobel Coating's corrosion resisting backer.

### Manufacturing Specifications

Quad Soffit Panel:	A) 16" side x 12'-0" long 1) Packed 12 pcs./carton, 192 sq. ft. 2) Free Airflow Center Vent: 6.48 sq. in./Lft. of panel Full Vent: 12.96 sq. in./Lft. of panel B) Precuts are 16" wide x 12", and 24" 1) Packed 30 pcs./carton, 40 running feet
Steel Fascia Panel:	A) 4", 6", 8" and 10" wide x 10'0" long with stiffening ribs & woodgrain texture. 1) 4", 6", and 8" packed 20 pcs./carton, 200 lineal feet (Both finishes) Polyester Enamel & PVC Finishes 2) 10" packed 12 pcs./carton, 120 lineal feet (Both finishes) Polyester Enamel & PVC Finishes

All materials conform to QQ-A-250/2

All procedures, operations and specifications shall meet or exceed EDCO Quality Control Standard Procedures, including ICBO, BOCA and SBCC

# Metal Roofing & Accessories



## Shingle-Shake

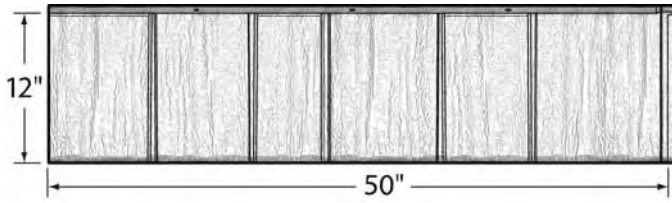

Product Code: 1720-\_\_ \_\_  
 Finish: Kynar 500®  
 Texture: Cedar-Grain  
 Thickness: 30 gauge  
 Coverage: 50" x 12"  
 Pieces/Ctn: 12  
 Sq Ft/Ctn: 50 sq ft  
 Lbs/Ctn: 38 lbs

203-Royal Brown	218-Desert Tone
206-Hartford Green	227-Classic Red
207-Classic Blue	228-Charcoal Gray
208-T-Tone	231-Spruce Green
212-Sandtone	258-Bright Red
213-Statuary Bronze	260-Copper
214-Glacier White	261-Cedar
216-Pewter	

## Slate



Product Code: 1748-\_\_ \_\_  
 Finish: Kynar 500®  
 Texture: Rough Slate  
 Thickness: 28 gauge  
 Coverage: 50" x 12"  
 Pieces/Ctn: 12  
 Sq Ft/Ctn: 50 sq ft  
 Lbs/Ctn: 45 lbs

206-Hartford Green	228-Charcoal Gray
227-Classic Red	257-Stone

## Enhanced Shingle-Shake

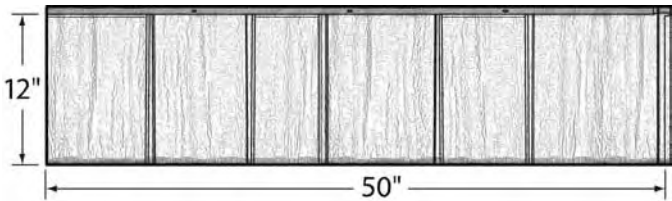

Product Code: 1754-\_\_ \_\_  
 Finish: Kynar 500®  
 Texture: Cedar-Grain  
 Thickness: 30 gauge  
 Coverage: 50" x 12"  
 Pieces/Ctn: 12  
 Sq Ft/Ctn: 50 sq ft  
 Lbs/Ctn: 38 lbs

### Blended Colors

293-T-tone Blend  
 294-Charcoal Gray Blend  
 295-Hartford Green Blend  
 296-Royal Brown Blend

## Enhanced Slate



Product Code: 1755-\_\_ \_\_  
 Finish: Kynar 500®  
 Texture: Rough Slate  
 Thickness: 28 gauge  
 Coverage: 50" x 12"  
 Pieces/Ctn: 12  
 Sq Ft/Ctn: 50 sq ft  
 Lbs/Ctn: 45 lbs

### Blended Colors

294-Charcoal Gray Blend  
 298-Classic Red Blend  
 299-Stone Blend

## Eave Starter

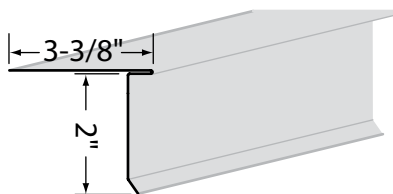

Product Code: 1721-\_\_ \_\_  
 Finish: Kynar 500®  
 Length: 10'  
 Thickness: 28 gauge  
 Pieces/Ctn: 10  
 Lbs/Ctn: 38 lbs

203-Royal Brown	214-Glacier White	257-Stone
206-Hartford Green	216-Pewter	258-Bright Red
207-Classic Blue	218-Desert Tone	260-Copper
208-T-Tone	227-Classic Red	261-Cedar
212-Sandtone	228-Charcoal Gray	
213-Statuary Bronze	231-Spruce Green	

# Metal Roofing Accessories



## Rake Starter

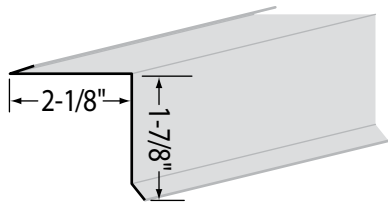

Product Code: 1722-\_\_\_\_  
 Finish: Kynar 500®  
 Length: 10'  
 Thickness: 28 gauge  
 Pieces/Ctn: 10  
 Lbs/Ctn: 28 lbs

- |                     |                   |                |
|---------------------|-------------------|----------------|
| 203-Royal Brown     | 214-Glacier White | 257-Stone      |
| 206-Hartford Green  | 216-Pewter        | 258-Bright Red |
| 207-Classic Blue    | 218-Desert Tone   | 260-Copper     |
| 208-T-Tone          | 227-Classic Red   | 261-Cedar      |
| 212-Sandtone        | 228-Charcoal Gray |                |
| 213-Statuary Bronze | 231-Spruce Green  |                |

## 7/8" J-Trim

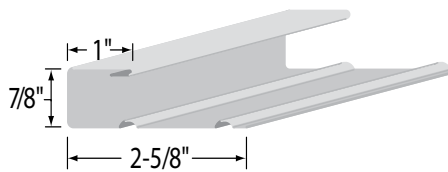

Product Code: 1723-\_\_\_\_  
 Finish: Kynar 500®  
 Length: 10'  
 Thickness: 28 gauge  
 Pieces/Ctn: 10  
 Lbs/Ctn: 28 lbs

- |                     |                   |                |
|---------------------|-------------------|----------------|
| 203-Royal Brown     | 214-Glacier White | 257-Stone      |
| 206-Hartford Green  | 216-Pewter        | 258-Bright Red |
| 207-Classic Blue    | 218-Desert Tone   | 260-Copper     |
| 208-T-Tone          | 227-Classic Red   | 261-Cedar      |
| 212-Sandtone        | 228-Charcoal Gray |                |
| 213-Statuary Bronze | 231-Spruce Green  |                |

## End Wall Flashing

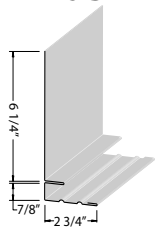

Product Code: 1747-\_\_\_\_  
 Finish: Kynar 500®  
 Length: 10'  
 Thickness: 28 gauge  
 Pieces/Ctn: 5  
 Lbs/Ctn: 43 lbs

- |                     |                   |                |
|---------------------|-------------------|----------------|
| 203-Royal Brown     | 214-Glacier White | 257-Stone      |
| 206-Hartford Green  | 216-Pewter        | 258-Bright Red |
| 207-Classic Blue    | 218-Desert Tone   | 260-Copper     |
| 208-T-Tone          | 227-Classic Red   | 261-Cedar      |
| 212-Sandtone        | 228-Charcoal Gray |                |
| 213-Statuary Bronze | 231-Spruce Green  |                |

## Ridge/Hip Cap-Shake

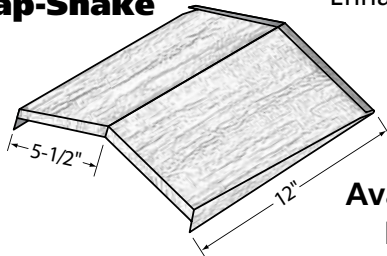

Product Code: 1726-\_\_\_\_  
 Enhanced Code: 1756-\_\_\_\_  
 Finish: Kynar 500®  
 Texture: Woodgrain  
 Thickness: 28 gauge  
 Pieces/Ctn: 20  
 Lbs/Ctn: 15 lbs

**Available in Solid and Enhanced Colors**

### Solid Colors

- |                    |                     |                   |
|--------------------|---------------------|-------------------|
| 203-Royal Brown    | 213-Statuary Bronze | 228-Charcoal Gray |
| 206-Hartford Green | 214-Glacier White   | 231-Spruce Green  |
| 207-Classic Blue   | 216-Pewter          | 258-Bright Red    |
| 208-T-Tone         | 218-Desert Tone     | 260-Copper        |
| 212-Sandtone       | 227-Classic Red     | 261-Cedar         |

### Enhanced Colors

- |                         |                          |
|-------------------------|--------------------------|
| 293-T-tone Blend        | 295-Hartford Green Blend |
| 294-Charcoal Gray Blend | 296-Royal Brown Blend    |

## Ridge/Hip Cap-Slate

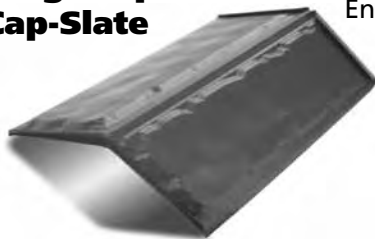

Product Code: 1750-\_\_\_\_  
 Enhanced Code: 1757-\_\_\_\_  
 Finish: Kynar 500®  
 Texture: Rough Slate  
 Thickness: 28 gauge  
 Pieces/Ctn: 20  
 Lbs/Ctn: 15 lbs

**Available in Solid and Enhanced Colors**

### Solid Colors

- |                    |                   |
|--------------------|-------------------|
| 206-Hartford Green | 228-Charcoal Gray |
| 227-Classic Red    | 257-Stone         |

### Enhanced Colors

- |                         |                 |
|-------------------------|-----------------|
| 294-Charcoal Gray Blend | 299-Stone Blend |
| 298-Classic Red Blend   |                 |

## Trim Coil

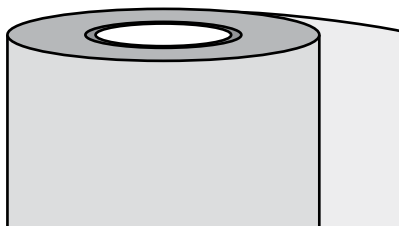

Product Code: 1730-\_\_\_\_  
 Finish: Velvet  
 Width: 14 1/4"  
 Length: 50'  
 Thickness: 28 gauge  
 Lbs: 45 lbs

- |                     |                   |                |
|---------------------|-------------------|----------------|
| 203-Royal Brown     | 214-Glacier White | 257-Stone      |
| 206-Hartford Green  | 216-Pewter        | 258-Bright Red |
| 207-Classic Blue    | 218-Desert Tone   | 260-Copper     |
| 208-T-Tone          | 227-Classic Red   | 261-Cedar      |
| 212-Sandtone        | 228-Charcoal Gray |                |
| 213-Statuary Bronze | 231-Spruce Green  |                |

# Shingle-Shake & Accessories



## Snow Guard

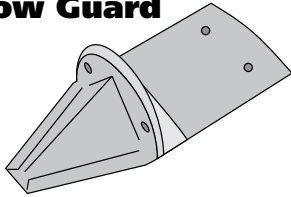

Product Code: 1753-\_\_\_\_  
 Finish: Kynar 500®  
 Thickness: 28 gauge  
 Pieces/Ctn: 50  
 Lbs/Ctn: 22 lbs

203-Royal Brown	214-Glacier White	257-Stone
206-Hartford Green	216-Pewter	258-Bright Red
207-Classic Blue	218-Desert Tone	260-Copper
208-T-Tone	227-Classic Red	261-Cedar
212-Sandtone	228-Charcoal Gray	
213-Statuary Bronze	231-Spruce Green	

## Valley Cap

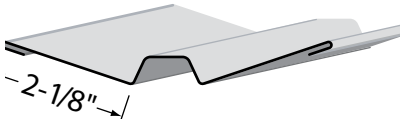

Product Code: 1734-\_\_\_\_  
 Finish: Kynar 500®  
 Length: 10'  
 Thickness: 28 gauge  
 Pieces/Ctn: 5  
 Lbs/Ctn: 19 lbs

Used with Valley Flashing #1727-\_\_\_\_

203-Royal Brown	214-Glacier White	257-Stone
206-Hartford Green	216-Pewter	258-Bright Red
207-Classic Blue	218-Desert Tone	260-Copper
208-T-Tone	227-Classic Red	261-Cedar
212-Sandtone	228-Charcoal Gray	
213-Statuary Bronze	231-Spruce Green	

## Valley Flashing

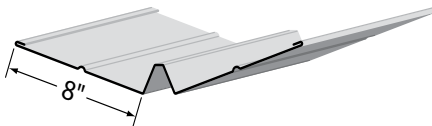

Product Code: 1727-\_\_\_\_  
 Length: 10'  
 Thickness: 28 gauge  
 Pieces/Ctn: 5  
 Lbs/Ctn: 55 lbs

203-Royal Brown	214-Glacier White	257-Stone
206-Hartford Green	216-Pewter	258-Bright Red
207-Classic Blue	218-Desert Tone	260-Copper
208-T-Tone	227-Classic Red	261-Cedar
212-Sandtone	228-Charcoal Gray	
213-Statuary Bronze	231-Spruce Green	

## Open Valley Starter

Product Code: 1728-000  
 Length: 10'  
 Thickness: 28 gauge  
 Pieces/Ctn: 5  
 Lbs/Ctn: 1bs

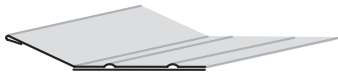

Used with Valley Flashing #1727-\_\_\_\_

## Starter Base w/o Foam

Product Code: 1725-000  
 Length: 10'  
 Thickness: 28 gauge  
 Pieces/Ctn: 5  
 Lbs/Ctn: 28 lbs

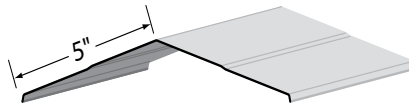

## Starter Base w/Foam Seal

Product Code: 1724-000  
 Length: 10'  
 Thickness: 28 gauge  
 Pieces/Ctn: 5  
 Lbs/Ctn: 30 lbs

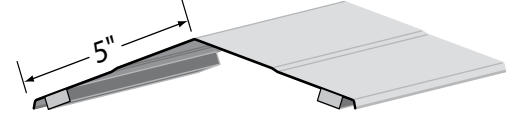

## 9" TrimLine Vent w/Foam Seal

Product Code: 1733-000  
 Length: 10'  
 Pieces/Ctn: 10  
 Lbs/Ctn: 43 lbs

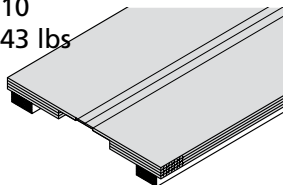

## Shingle Clip

Product Code: 1731-000  
 Thickness: 26 gauge  
 Pieces/Ctn: 750  
 Lbs/Ctn: 16 lbs  
 (Valley Clip # 1732-000)

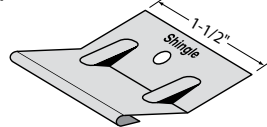

## Wind & Water Seal

Product Code: 3730-000  
 Width: 36"  
 Length: 75'  
 Sq Ft/Roll: 225 sq ft  
 Lbs/Roll: 55 lbs

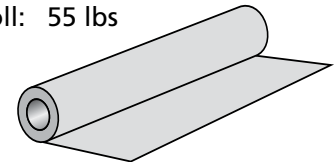

## Touch-Up Paint

Product Code: 3739-\_\_\_\_  
 Oz/Bottle: 1/2 oz  
 Pieces/Ctn: 12  
 Lbs/Ctn: 1 lb  
 Available in all colors



## Sub Seal 40

Product Code: 3732-000  
 Length: 75'  
 Width: 6"

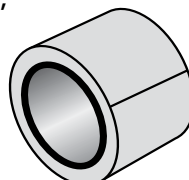

## Foam Seal

Product Code: 3734-000  
 Width: 1 3/16"  
 Thickness: 5/8"  
 Length: 20'  
 Lbs: 1 lb

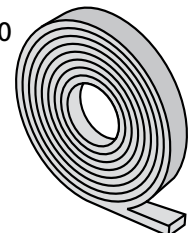



# Shingle & Slate Specifications



<b>Rating</b>	<b>Results</b>
FM-4470 Foot Traffic/Hail Resistance . . . . .	Is resistant to severe hail and foot traffic
UL – 1897 Uplift Resistance . . . . .	Up to 160 mph rating with 5 clips and screws
UL – 2218 Hail / Impact Resistance . . . . .	Class 4 rating (Highest possible rating)
ICBO AC07 Penetration Resistance . . . . .	200 lbs. pressure, minimum deformation
ASTM A90-95 Galvanization . . . . .	Meets or exceeds G90 standardPerformance
UL – 790 Fire Resistance . . . . .	Class A over Densdeck or Versashield Class C over 30# felt paper
Florida Building Code # FL 4077 . . . . .	Hurricane Testing (Slate ONLY)

## Coating Performance (Testing performed by Akzo Nobel)

ASTM D – 3361 Accelerated Weathering . . . . .	Hours: 1000 Chalk: Rating 8 Color: 5E Hunter units maximum
ASTM B – 117 Salt Spray . . . . .	Hours: 1000 hours Scribe Rating: 7, 1/16” Field: Rating 10, no adhesion loss or blisters
ASTM D – 2247 Humidity . . . . .	Hours: 1500 hours Rating: 10, no blisters, cracking, or softening
ASTM D – 4145 Formability . . . . .	0T to 1T
ASTM D – 3363 Pencil Hardness . . . . .	F to H
ASTM D – 2794 Reverse Impact . . . . .	80 Lbs with no loss of adhesion
ASTM D – 523 Specular Gloss . . . . .	8 – 12% at 60
ATSM D-522 . . . . .	No loss of adhesion (Elongation over 1/8” Cylindrical mandrel)
ASTM E – 84 Flame hazard test . . . . .	Class A / Class 1 coating
ASTM D – 5402 cure test . . . . .	100 rubs

## Material Specifications

Gauge: Shingle - Shake . . . . .	30 Gauge Painted Galvanized Steel
Gauge: Slate . . . . .	28 Gauge Painted Galvanized Steel
Minimum Slope: . . . . .	4” in 12”
Panel Exposure Area: . . . . .	12” x 50”
Panel Coverage: . . . . .	4.17 sq. ft. / panel
Panels Per Box: . . . . .	12 panels (50 sq. ft. / box)
Weight: Shingle - Shake . . . . .	38 lbs. / box (76 lbs./sq. approx.)
Weight: Slate . . . . .	45 lbs. / box (90 lbs./sq. approx.)
Clip Material: . . . . .	.024” Galvanized Steel
Shingle Material: . . . . .	Nominal 0.0135” thickness, including G90 galvanization and paint coating. Exterior finish is Kynar 500® / Hylar 500®, 1 mil thickness, with anti-corrosive primer. Interior finish is a wash coat, 0.6 mil thickness with anti-corrosive primer.
Slate Material: . . . . .	Nominal 0.0160” thickness, including G90 galvanization and paint coating. Exterior finish is Kynar 500® / Hylar 500®, 1 mil thickness, with anti-corrosive primer. Interior finish is a wash coat, 0.6 mil thickness with anti-corrosive primer.

# Rainware: Gutters & Downspouts

## Aluminum Gutter

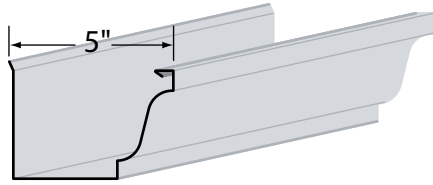

Product Code: 1149-\_\_-\_\_  
 Finish: Enamel/PVC  
 Entex  
 Width: 5"  
 Length: Up to 40'  
 Thickness: .032" Enamel  
 .032" Entex  
 .032" PVC

## Enamel

001-Polar White	007-Classic Blue	014-Glacier White
002-Almond Cream	008-T-Tone	015-Antique Parchment
003-Royal Brown	009-Claytone	016-Pewter
004-Adobe Cream	010-Heritage Gray	017-Wickertone
005-Autumn Beige	012-Sandtone	018-Desert Tone
006-Hartford Green	013-Statuary Bronze	

## PVC

109-Claytone	120-Colonial White	127-Classic Red
114-Glacier White	121-Sand Beige	128-Charcoal Gray
115-Antique Parchment	122-Rustic Brown	133-Heritage Blue
117-Wickertone	125-Slate Blue	134-Sherwood Green
118-Desert Tone	126-Driftwood Gray	

## Entex

707-Classic Blue	718-Desert Tone	786-Canyon
708-T-tone	728-Charcoal Gray	792-Willow
712-Sandtone	732-Cedar	
714-Glacier White	785-Mahogany	

## 5" Gutter Guard Black Galvanized

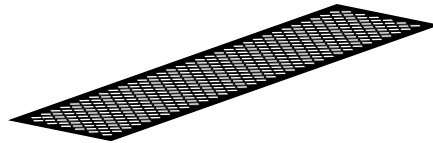

Product Code: 3222-011  
 Length: 4'  
 Pieces/Ctn: 25  
 Lbs/Ctn: 8 lbs

## 6" Gutter Guard Aluminum

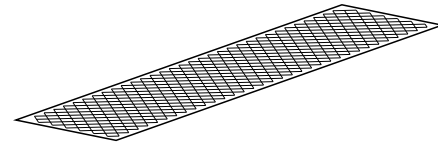

Product Code: 3220-000  
 Length: 3'  
 Pieces/Ctn: 50  
 Lbs/Ctn: 10 lbs

## 2" x 3" Aluminum Downspout

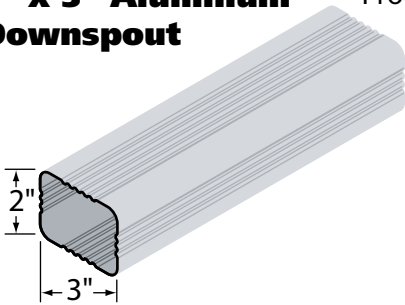

Product Code: 1257-\_\_-\_\_  
 Finish: Enamel/PVC  
 Length: 10'  
 Thickness: .019"  
 Pieces/Ctn: 10  
 Lbs/Ctn: 25 lbs

## Enamel

001-Polar White	007-Classic Blue	014-Glacier White
002-Almond Cream	008-T-Tone	015-Antique Parchment
003-Royal Brown	009-Claytone	016-Pewter
004-Adobe Cream	010-Heritage Gray	017-Wickertone
005-Autumn Beige	012-Sandtone	018-Desert Tone
006-Hartford Green	013-Statuary Bronze	

## PVC

120-Colonial White	121-Sand Beige	122-Rustic Brown
--------------------	----------------	------------------

## 2" x 3" Aluminum Elbows

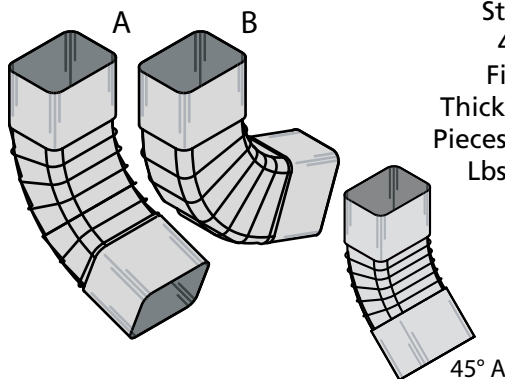

Product Code:  
 Style A 1258-\_\_-\_\_  
 Style B 1259-\_\_-\_\_  
 45° A 1262-\_\_-\_\_  
 Finish: Enamel/PVC  
 Thickness: .019"  
 Pieces/Ctn: 30  
 Lbs/Ctn: 26 lbs

## Enamel

001-Polar White	007-Classic Blue	014-Glacier White
002-Almond Cream	008-T-Tone	015-Antique Parchment
003-Royal Brown	009-Claytone	016-Pewter
004-Adobe Cream	010-Heritage Gray	017-Wickertone
005-Autumn Beige	012-Sandtone	018-Desert Tone
006-Hartford Green	013-Statuary Bronze	

## PVC

120-Colonial White	121-Sand Beige	122-Rustic Brown
--------------------	----------------	------------------

*45° A Elbows only available in Enamel*

# Rainware: Gutters & Downspouts

## 3" x 4" Aluminum Downspout

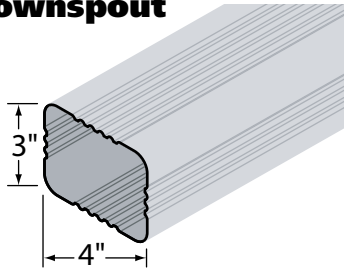

Product Code: 1245-\_\_\_  
 Finish: Enamel  
 Length: 10'  
 Thickness: .019"  
 Pieces/Ctn: 10  
 Lbs/Ctn: 32 lbs

### Enamel

001-Polar White	007-Classic Blue	014-Glacier White
002-Almond Cream	008-T-Tone	015-Antique Parchment
003-Royal Brown	009-Claytone	016-Pewter
004-Adobe Cream	010-Heritage Gray	017-Wickertone
005-Autumn Beige	012-Sandtone	018-Desert Tone
006-Hartford Green	013-Statuary Bronze	

## 3" x 4" Aluminum Elbows

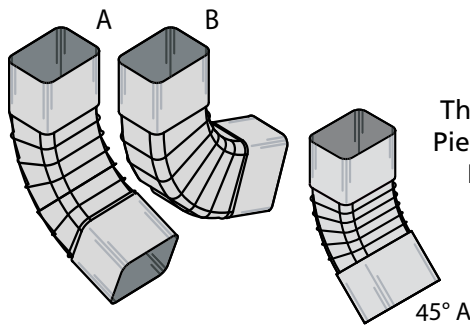

Product Code:  
 Style A 1246-\_\_\_  
 Style B 1247-\_\_\_  
 45° A 1248-\_\_\_  
 Finish: Enamel  
 Thickness: .019"  
 Pieces/Ctn: 20  
 Lbs/Ctn: 10 lbs

### Enamel

001-Polar White	007-Classic Blue	014-Glacier White
002-Almond Cream	008-T-Tone	015-Antique Parchment
003-Royal Brown	009-Claytone	016-Pewter
004-Adobe Cream	010-Heritage Gray	017-Wickertone
005-Autumn Beige	012-Sandtone	018-Desert Tone
006-Hartford Green	013-Statuary Bronze	

## Aluminum Downspout U-Band

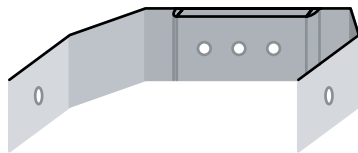

Product Code:  
 2" x 3" 1263-\_\_\_  
 3" x 4" 1264-\_\_\_  
 Finish: Enamel/PVC  
 Entex  
 Thickness: .032" Enamel  
 .032" Entex  
 .032" PVC  
 Pieces/Ctn: 100  
 Lbs/Ctn: 6 / 10 lbs

### Enamel

001-Polar White	007-Classic Blue	014-Glacier White
002-Almond Cream	008-T-Tone	015-Antique Parchment
003-Royal Brown	009-Claytone	016-Pewter
004-Adobe Cream	010-Heritage Gray	017-Wickertone
005-Autumn Beige	012-Sandtone	018-Desert Tone
006-Hartford Green	013-Statuary Bronze	

### PVC

109-Claytone	120-Colonial White	127-Classic Red
114-Glacier White	121-Sand Beige	128-Charcoal Gray
115-Antique Parchment	122-Rustic Brown	133-Heritage Blue
117-Wickertone	125-Slate Blue	134-Sherwood Green
118-Desert Tone	126-Driftwood Gray	

### Entex

707-Classic Blue	718-Desert Tone	786-Canyon
708-T-tone	728-Charcoal Gray	792-Willow
712-Sandtone	732-Cedar	
714-Glacier White	785-Mahogany	

## Aluminum Downspout Pipe Band



Product Code: 1260-\_\_\_  
 Finish: Enamel/PVC  
 Entex  
 Thickness: .019"  
 Pieces/Ctn: 100  
 Lbs/Ctn: 6 lbs

### Enamel

001-Polar White	003-Royal Brown	012-Sandtone
002-Almond Cream	008-T-Tone	

### PVC

120-Colonial White	121-Sand Beige	122-Rustic Brown
--------------------	----------------	------------------

### Entex

707-Classic Blue	718-Desert Tone	786-Canyon
708-T-tone	728-Charcoal Gray	792-Willow
712-Sandtone	732-Cedar	
714-Glacier White	785-Mahogany	

# Rainware: Gutters & Downspouts

## 2" x 3" Steel Downspout

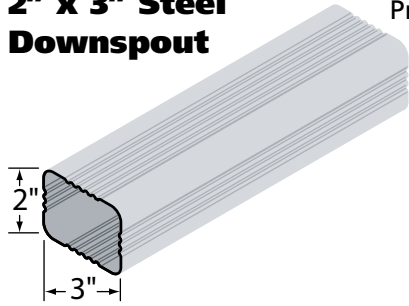

Product Code: 1289-\_\_\_\_  
 Finish: PVC / Entex  
 Length: 10'  
 Thickness: 29 gauge  
 Pieces/Ctn: 10  
 Lbs/Ctn: 54 lbs

### PVC

109-Claytone	121-Sand Beige	128-Charcoal Gray
114-Glacier White	122-Rustic Brown	129-Yellow Glow
115-Antique Parchment	123-Spring Green	133-Heritage Blue
117-Wickertone	125-Slate Blue	134-Sherwood Green
118-Desert Tone	126-Driftwood Gray	
120-Colonial White	127-Classic Red	

### Entex

707-Classic Blue	718-Desert Tone	786-Canyon
708-T-tone	728-Charcoal Gray	792-Willow
712-Sandtone	732-Cedar	
714-Glacier White	785-Mahogany	

## 3" x 4" Steel Downspout

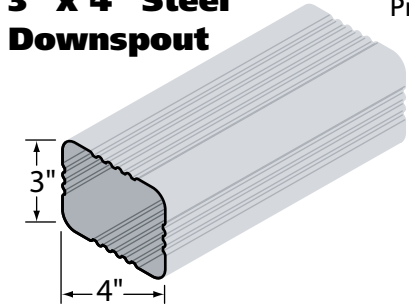

Product Code: 1295-\_\_\_\_  
 Finish: Enamel/PVC  
 Entex  
 Length: 10'  
 Thickness: 29 gauge  
 Pieces/Ctn: 10  
 Lbs/Ctn: 76 lbs

### Enamel

001-Polar White

### PVC

109-Claytone	120-Colonial White	127-Classic Red
114-Glacier White	121-Sand Beige	128-Charcoal Gray
115-Antique Parchment	122-Rustic Brown	133-Heritage Blue
117-Wickertone	125-Slate Blue	134-Sherwood Green
118-Desert Tone	126-Driftwood Gray	

### Entex

707-Classic Blue	718-Desert Tone	786-Canyon
708-T-tone	728-Charcoal Gray	792-Willow
712-Sandtone	732-Cedar	
714-Glacier White	785-Mahogany	

## 2" x 3" Steel Elbows

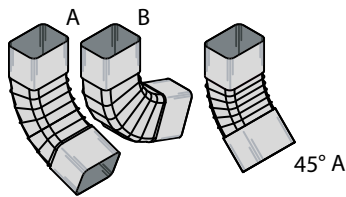

Product Code:  
 2" x 3" Style A 1290-\_\_\_\_  
 2" x 3" Style B 1291-\_\_\_\_  
 2" x 3" 45° A 1287-\_\_\_\_  
 Finish: PVC / Entex  
 Thickness: 29 gauge  
 Pieces/Ctn: 30  
 Lbs/Ctn: 13 lbs

### PVC

109-Claytone	121-Sand Beige	128-Charcoal Gray
114-Glacier White	122-Rustic Brown	129-Yellow Glow
115-Antique Parchment	123-Spring Green	133-Heritage Blue
117-Wickertone	125-Slate Blue	134-Sherwood Green
118-Desert Tone	126-Driftwood Gray	
120-Colonial White	127-Classic Red	

### Entex

707-Classic Blue	718-Desert Tone	786-Canyon
708-T-tone	728-Charcoal Gray	792-Willow
712-Sandtone	732-Cedar	
714-Glacier White	785-Mahogany	

## 3" x 4" Steel Elbows

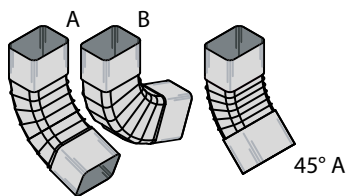

Product Code:  
 3" x 4" Style A 1296-\_\_\_\_  
 3" x 4" Style B 1297-\_\_\_\_  
 3" x 4" 45° A 1298-\_\_\_\_  
 Finish: PVC / Entex  
 Thickness: 29 gauge  
 Pieces/Ctn: 20  
 Lbs/Ctn: 17 lbs

### PVC

109-Claytone	120-Colonial White	127-Classic Red
114-Glacier White	121-Sand Beige	128-Charcoal Gray
115-Antique Parchment	122-Rustic Brown	133-Heritage Blue
117-Wickertone	125-Slate Blue	134-Sherwood Green
118-Desert Tone	126-Driftwood Gray	

### Entex

707-Classic Blue	718-Desert Tone	786-Canyon
708-T-tone	728-Charcoal Gray	792-Willow
712-Sandtone	732-Cedar	
714-Glacier White	785-Mahogany	

# Rainware: Gutters & Downspouts

## Aluminum End Caps

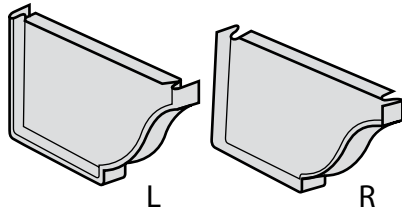

Product Code:  
 Left 1265\_\_  
 Right 1266\_\_  
 Finish: Enamel/PVC  
 Entex  
 Thickness: .019"  
 Pieces/Ctn: 50  
 Lbs/Ctn: 3 lbs

## Enamel

001-Polar White	007-Classic Blue	014-Glacier White
002-Almond Cream	008-T-Tone	015-Antique Parchment
003-Royal Brown	009-Claytone	016-Pewter
004-Adobe Cream	010-Heritage Gray	017-Wickertone
005-Autumn Beige	012-Sandtone	018-Desert Tone
006-Hartford Green	013-Statuary Bronze	

## Aluminum Outside Corner Mitre Section

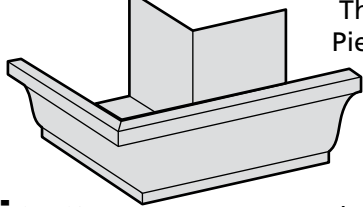

Product Code: 1252\_\_  
 Finish: Enamel/PVC  
 Entex  
 Thickness: .019"  
 Pieces/Ctn: 20  
 Lbs/Ctn: 7 lbs

## PVC

109-Claytone	120-Colonial White	127-Classic Red
114-Glacier White	121-Sand Beige	128-Charcoal Gray
115-Antique Parchment	122-Rustic Brown	133-Heritage Blue
117-Wickertone	125-Slate Blue	134-Sherwood Green
118-Desert Tone	126-Driftwood Gray	

## Aluminum Inside Corner Mitre Section

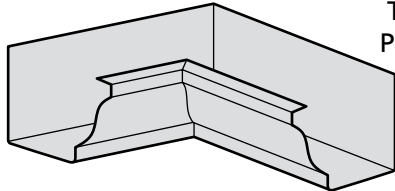

Product Code: 1253\_\_  
 Finish: Enamel/PVC  
 Entex  
 Thickness: .019"  
 Pieces/Ctn: 20  
 Lbs/Ctn: 7 lbs

## Entex

707-Classic Blue	718-Desert Tone	786-Canyon
708-T-tone	728-Charcoal Gray	792-Willow
712-Sandtone	732-Cedar	
714-Glacier White	785-Mahogany	

## Aluminum Outside Strip Mitre

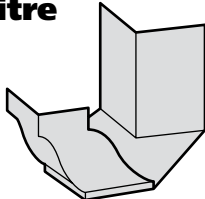

Product Code:  
 90°: 1255-\_\_-\_\_  
 45°: 3250-001  
 Finish: Enamel or  
 Entex  
 Thickness: .019"  
 Pieces/Ctn: 20  
 Lbs/Ctn: 3 lbs

## Enamel

001-Polar White	009-Claytone	015-Antique Parchment
003-Royal Brown	012-Sandtone	017-Wickertone
008-T-Tone	014-Glacier White	

## Entex

707-Classic Blue	718-Desert Tone	786-Canyon
708-T-tone	728-Charcoal Gray	792-Willow
712-Sandtone	732-Cedar	
714-Glacier White	785-Mahogany	

*45° Outside Strip Mitre only available in 001-Polar White*  
*45° Inside Strip Mitre only available in 001-Polar White*

## Aluminum Inside Strip Mitre

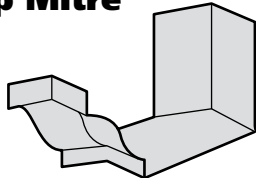

Product Code:  
 90°: 1256-\_\_-\_\_  
 45°: 3251-001  
 Finish: Enamel or  
 Entex  
 Thickness: .019"  
 Pieces/Ctn: 20  
 Lbs/Ctn: 3 lbs

## Aluminum Slip Joint Gutter Connector

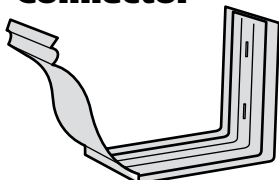

Product Code: 3201-001  
 Finish: Enamel  
 Thickness: .019"  
 Pieces/Ctn: 50  
 Lbs/Ctn: 5 lbs

## Enamel

001-Polar White

# Rainware: Gutters & Downspouts

## Aluminum Gutter Roof Apron

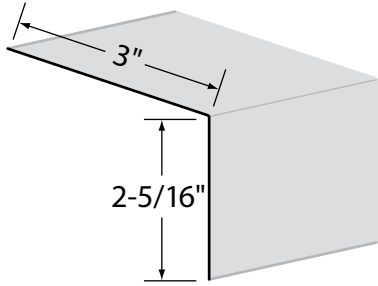

Product Code: 1268 - \_\_\_\_  
 Finish: Enamel/PVC  
 Entex  
 Length: 12'  
 Thickness: .019"  
 Pieces/Ctn: 25  
 Lbs/Ctn: 40 lbs

## Enamel

001-Polar White	007-Classic Blue	014-Glacier White
002-Almond Cream	008-T-Tone	015-Antique Parchment
003-Royal Brown	009-Claytone	016-Pewter
004-Adobe Cream	010-Heritage Gray	017-Wickertone
005-Autumn Beige	012-Sandtone	018-Desert Tone
006-Hartford Green	013-Statuary Bronze	

## PVC

109-Claytone	120-Colonial White	127-Classic Red
114-Glacier White	121-Sand Beige	128-Charcoal Gray
115-Antique Parchment	122-Rustic Brown	133-Heritage Blue
117-Wickertone	125-Slate Blue	134-Sherwood Green
118-Desert Tone	126-Driftwood Gray	

## Entex

707-Classic Blue	718-Desert Tone	786-Canyon
708-T-tone	728-Charcoal Gray	792-Willow
712-Sandtone	732-Cedar	
714-Glacier White	785-Mahogany	

## Aluminum Drop Outlet Tube Round

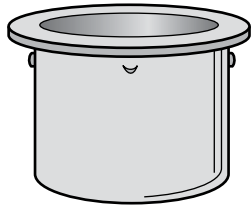

Product Code:  
 2-3/8" 3245-000  
 2-3/4" 3247-000  
 Finish: Mill Finish  
 Thickness: .019"  
 Pieces/Ctn: 250  
 Lbs/Ctn: 7.5 lbs

## Aluminum Drop Outlet Tube Rectangle

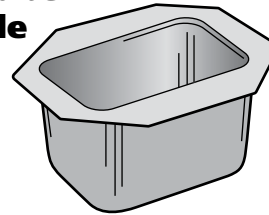

Product Code:  
 2" x 3" 3246-000  
 3" x 4" 3248-000  
 Finish: Mill Finish  
 Thickness: .019"  
 Pieces/Ctn: 200/50  
 Lbs/Ctn: 6 lbs

## Aluminum Gutter Coil

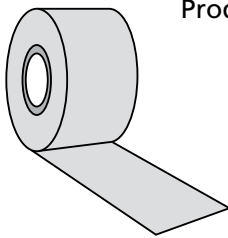

Product Code:  
 Enamel: 1284 - \_\_\_\_  
 PVC: 1284 - \_\_\_\_  
 Finish: Enamel/PVC  
 Entex  
 Width: 11-7/8'  
 Thickness: .032" Enamel  
 2.25 ft/lb  
 .032" Entex  
 2.25 ft/lb  
 .032" PVC  
 2.25 ft/lb  
 Lbs/Roll: 300-400 lbs

## Enamel

001-Polar White	007-Classic Blue	014-Glacier White
002-Almond Cream	008-T-Tone	015-Antique Parchment
003-Royal Brown	009-Claytone	016-Pewter
004-Adobe Cream	010-Heritage Gray	017-Wickertone
005-Autumn Beige	012-Sandtone	018-Desert Tone
006-Hartford Green	013-Statuary Bronze	

## PVC

109-Claytone	120-Colonial White	127-Classic Red
114-Glacier White	121-Sand Beige	128-Charcoal Gray
115-Antique Parchment	122-Rustic Brown	133-Heritage Blue
117-Wickertone	125-Slate Blue	134-Sherwood Green
118-Desert Tone	126-Driftwood Gray	

## Aluminum Gutter Mini Coil

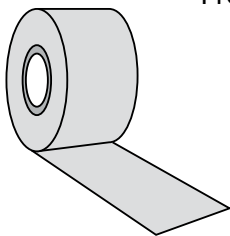

Product Code: 1286 - \_\_\_\_  
 Finish: Enamel/PVC  
 Entex  
 Width: 11-7/8'  
 Thickness: .032" Enamel  
 .032" Entex  
 .032" PVC  
 Length: 150'  
 Lbs/Ctn: 75 lbs

## Entex

707-Classic Blue	718-Desert Tone	786-Canyon
708-T-tone	728-Charcoal Gray	792-Willow
712-Sandtone	732-Cedar	
714-Glacier White	785-Mahogany	

# Rainware: Gutters & Downspouts

## Combo Fascia Hanger

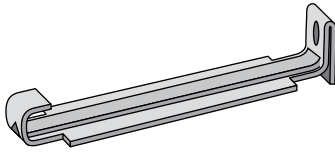

Product Code:  
 Galv Steel 5": 3294-000  
 Galv Steel 6": 3295-000  
 Install O.C.: 32" o.c.  
 Pieces/Ctn:  
 Galv Steel 5": 500  
 Galv Steel 6": 100  
 Lbs/Ctn: 48/16 lbs

## Sampson Hanger

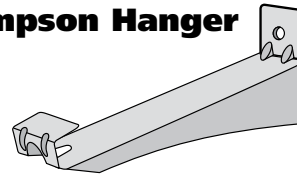

Product Code:  
 100 Pcs/Ctn: 3208-000  
 900 Pcs/Keg: 3209-000  
 Lbs/Ctn: 5/45 lbs

## Heavy-Duty Aluminum Roof Hanger



Product Code:  
 50 Pcs/Ctn: 3212-000  
 1800 Pcs/Keg: 3213-000  
 Install O.C.: 32" o.c.  
 Lbs/Ctn: 5/180 lbs

## Combo Strap

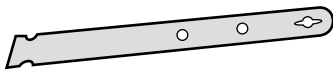

Product Code:  
 Aluminum: 3211-000  
 Galv Steel: 3296-000  
 Install O.C.: 32" o.c.  
 Pieces/Ctn: 100  
 Lbs/Ctn: 4/11 lbs

## Spike: Aluminum



Product Code: 3230-\_\_\_  
 Pieces/Ctn: 500  
 Lbs/Ctn: .031 lbs

*Available in 01-Polar White & 03-Royal Brown*

## Spike: Steel



Product Code: 3292-\_\_\_  
 Pieces/Ctn: 800  
 Lbs/Ctn: .063 lbs

*Available in 01-Polar White, 03-Royal Brown, and Mill Finish*

## Raytec Hangtite Fascia Hanger



Product Code:  
 Aluminum 5": 3204-000  
 Alum 5" Keg: 3205-000  
 Install O.C.: 32" o.c.  
 Pieces/Ctn: 100  
 Pieces/Keg: 3000  
 Lbs/Ctn: 4 lbs  
 Lbs/Keg: 200 lbs

## Ferrule: Aluminum



Product Code: 3231-000  
 Pieces/Ctn: 500  
 Lbs/Ctn: .01 lbs

*Available in Mill Finish*

## Ferrule: Steel



Product Code: 3293-000  
 Pieces/Ctn: 500  
 Lbs/Ctn: .063 lbs

*Available in Mill Finish*

## Vampire Gutter Hanger

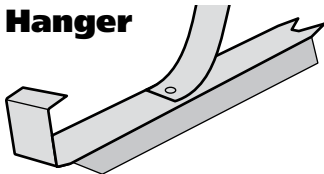

Product Code: 3206-000  
 Pieces/Ctn: 100  
 Lbs/Ctn: 8 lbs

## Gutter Screw

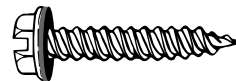

Product Code:  
 #10 x 1-1/2" 3286-000  
 Length: 1-1/2"  
 Pieces/Bag: 250  
 Bags/Ctn: 20  
 Pieces/Ctn: 5000  
 Lbs/Ctn: 20 lbs

## Vampire Gutter Hanger Tool

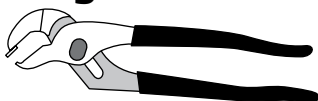

Product Code: 3270-000  
 Lbs: 1 lbs

# Gutter & Rainware Specifications

---

## ALUMA-KORE® ALUMINUM GUTTER SYSTEMS (Available in Enamel, PVC and Entex Finishes)

### General Characteristics

Aluma-Kore® Aluminum Gutter system is intended for exterior overhang installations on residential or commercial buildings.

### Material Specifications

Gutter - Metal      Nominal .032" thick aluminum (All finishes), alloy 3105, hardness/temper H-15

Aluminum Tensile Strength (PSI): . . . . . 26,000<sup>1</sup>

Aluminum Yield Strength (PSI): . . . . . 25,000<sup>1</sup>

Aluminum Ult Sheer Strength (PSI): . . . 15,000<sup>1</sup>

Aluminum Endurance Limit (PSI): . . . 10,000<sup>1</sup>

### Material Paint Specifications

Paint Preparation:      Both sides of substrate chemically cleaned with an alkaline "Parco 338W" cleaner.  
Dry in place chrome conversion coating with Henkel "1402W Bonderite"  
applied to both sides of substrate.

**Enamel Paint System:**    Top Coat - Valspar "Ultra-Flex" thermo setting polyester system.  
Back Coat - Polyester corrosion resisting coating.

**PVC Paint System:**      Prime Coat - Akzo - Nobel Coating's "Prime-A-Sol" corrosion resistant primer.  
Top Coat - Akzo - Nobel Coating's chemical striated vinyl plastisol, applied 4 mil. thick system.  
Back Coat - Akzo - Nobel Coating's corrosion resisting backer

**Entex Paint System:**    Prime Coat - DuraCoat's DURAdhesion corrosion resistant Global Primer  
Top Coat - DuraCoat's XT-40S with DuraCool pigments, average thickness 1.0 mil  
Back Coat - Akzo - Nobel Coating's corrosion resisting backer.

### Manufacturing Specifications

Gutter:                      A) Standard K style, 5" width, custom lengths

All materials conform to QQ-A-250/2

All procedures, operations and specifications shall meet or exceed EDCO® Quality Control Standard Procedures, including ICBO, BOCA and SBCC



# Casing, Sills, & Other Trims

Specialty bends are available.  
Call for lead times.

## Aluminum Sill Cover

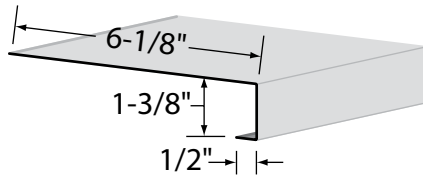

Product Code: 1357- \_ \_ \_  
Finish: Enamel  
Width: 6-1/8"  
Length: 12'  
Thickness: .019"  
Pieces/Ctn: 25  
Lbs/Ctn: 28 lbs

## Enamel

001-Polar White      014-Glacier White

## Aluminum Drip Cap

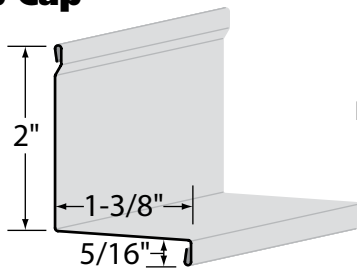

Product Code: 1359- \_ \_ \_  
Finish: Enamel  
Width: 1-3/8"  
Length: 12'  
Thickness: .019"  
Pieces/Ctn: 25  
Lbs/Ctn: 26 lbs

## Enamel

001-Polar White      012-Sandtone      014-Glacier White  
002-Almond Cream

## Steel Adjustable Drip Cap

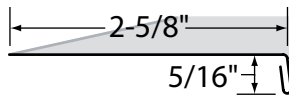

Product Code: 1360- \_ \_ \_  
Finish: PVC  
Width: 2-5/8"  
Length: 12'  
Thickness: 29 gauge  
Pieces/Ctn: 25  
Lbs/Ctn: 26 lbs

## PVC

109-Claytone	121-Sand Beige	128-Charcoal Gray
114-Glacier White	122-Rustic Brown	129-Yellow Glow
115-Antique Parchment	123-Spring Green	133-Heritage Blue
117-Wickertone	125-Slate Blue	134-Sherwood Green
118-Desert Tone	126-Driftwood Gray	
120-Colonial White	127-Classic Red	

## Aluminum Flat Casing Cover

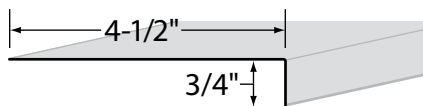

Product Code: 1365- \_ \_ \_  
Finish: Enamel  
Width: 4-1/2"  
Length: 12'  
Thickness: .019"  
Pieces/Ctn: 25  
Lbs/Ctn: 24 lbs

## Enamel

001-Polar White      014-Glacier White

## Aluminum Brick Casing Cover

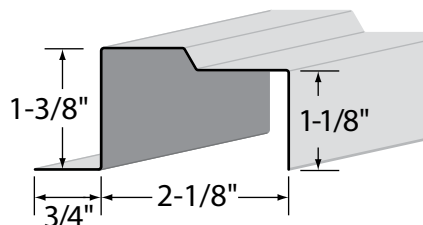

Product Code:  
12' Length: 1352- \_ \_ \_  
7' Length: 1353- \_ \_ \_  
Finish: Enamel/PVC  
Thickness: .019"  
Pieces/Ctn: 25  
Lbs/Ctn: 24 lbs

## Enamel

001-Polar White      006-Hartford Green      012-Sandtone  
003-Royal Brown      008-T-tone      014-Glacier White

1353-001 - 7' Length in 001-Polar White  
1353-014 - 7' Length in 014-Glacier White

## PVC

120-Col. White      114-Glacier White      134-Sherwood Green

# Adhesive & Sealant, Paint, Trim Nails

## OSI Quad Formula



Product Code: 3399-\_\_  
Capacity: 1/10 gal  
Pieces/Ctn: 12  
Lbs/Ctn: 14

## Touch-Up & Spray Paint



Product Code:  
Spray: 3401-\_\_  
Touch-Up: 3402-\_\_  
Capacity: 12/5 oz  
Pieces/Ctn: 12  
Lbs/Ctn: 7/1 lbs

## Enamel

001-Polar White	007-Classic Blue	014-Glacier White
002-Almond Cream	008-T-Tone	015-Antique Parchment
003-Royal Brown	009-Claytone	016-Pewter
004-Adobe Cream	010-Heritage Gray	017-Wickertone
005-Autumn Beige	012-Sandtone	018-Desert Tone
006-Hartford Green	013-Statuary Bronze	

## PVC

109-Claytone	121-Sand Beige	128-Charcoal Gray
114-Glacier White	122-Rustic Brown	129-Yellow Glow
115-Antique Parchment	123-Spring Green	133-Heritage Blue
117-Wickertone	125-Slate Blue	134-Sherwood Green
118-Desert Tone	126-Driftwood Gray	
120-Colonial White	127-Classic Red	

## Entex

707-Classic Blue	718-Desert Tone	786-Canyon
708-T-tone	728-Charcoal Gray	792-Willow
712-Sandtone	732-Cedar	
714-Glacier White	785-Mahogany	

## Painted Stainless Steel Trim Nails



Product Code: 3279-\_\_  
Lbs/Ctn: 1 lb

## Double Hot-Dipped Galv. Trim Nails



Product Code: 3278-\_\_  
Length: 1-1/2"  
Lbs/Ctn: 1 lb

001-Polar White	014-Glacier White	127-Classic Red
003-Royal Brown	015-Antique Parchment	128-Charcoal Gray
005-Autumn Beige	109-Claytone	133-Heritage Blue
006-Hartford Green	117-Wickertone	134-Sherwood Green
007-Classic Blue	118-Desert Tone	732-Cedar
008-T-Tone	121-Sand Beige	785-Mahogany
010-Heritage Gray	125-Slate Blue	786-Canyon
013-Statuary Bronze	126-Driftwood Gray	787-Willow

## Stainless Steel Trim Nails



Product Code: 20900  
Length: 1-3/4"  
Lbs/Ctn: 1 lb

## Mill Finish Zip Screw



Product Code:  
#8 x 1/2": 3281-000  
#8 x 1": 3282-000  
Qty/Ctn: 1000  
Lbs/Ctn: 3 lbs

## Maze Storm Guard Screw Shank Roofing Nail



Product Code:  
7/8": 3735-000  
1-3/4": 3738-000  
1-1/2" w/washer: 3736-000  
Lbs/Box: 5 lbs

## Mill Finish Zip Screw



Product Code:  
#10 x 1": 3283-000  
#10 x 1-1/2": 3284-000  
#10 x 2": 3285-000  
Qty/Ctn: 8000  
Lbs/Ctn: 24 lbs

## Painted Zip Screw (for use with roofing)



Product Code:  
#8 x 1/2": 3280-\_\_  
Pieces/Pkg: 100  
Pieces/Ctn: 1000

203-Royal Brown	214-Glacier White	258-Bright Red
206-Hartford Green	216-Pewter	259-Stone
207-Classic Blue	218-Desert Tone	260-Copper
208-T-Tone	227-Classic Red	261-Cedar
212-Sandtone	228-Charcoal Gray	
213-Statuary Bronze	231-Spruce Green	

## 1/8" Aluminum Pop-Rivet



Product Code: 3261-\_\_  
Pieces/Pkg: 100  
Weight/Pkg: .001 lbs

001-Polar White	008-T-Tone
002-Almond Cream	012-Sandtone
003-Royal Brown	126-Driftwood Gray

# Color Availability Matrix

ENTEX COLORS																					
4" Colonial Steel Siding	5" Dutch-Lap Steel Siding	6" Colonial Steel Siding	8" Clapboard Steel Siding	12" Vertical Batten Steel Siding	5" O.G. Gutter	3x4 Downspout: Steel	2x3 Downspout: Aluminum	2x3 Downspout: Steel	Soffit: Plain & Center Vented	Soffit: Full Vented	Fascia: Steel	Roof Drip Edge	Snap-On Frieze Trim	1-1/4" Wide-Face J-Trim	F-Trim	7/16" J-Trim	Mitre Molding	Coil Stock (See p12)	Steel Trim Nails	Glacier White	
																				Canyon	
																				Willow	
																				Desert Tone	
																				Classic Blue	
																				Sandtone	
																				T-tone	
																				Charcoal Gray	
																				Cedar	
																				Mahogany	
KYNAR COLORS																					
ArrowLine Shingle-Shake	ArrowLine Enhanced Shake	ArrowLine Enhanced Slate	Shake Ridge / Hip Cap (Solid)	Slate Ridge / Hip Cap (Solid)	Shake Ridge / Hip Cap (Enhanced)	Slate Ridge / Hip Cap (Enhanced)	Eave Starter	Rake Starter	7/8" J-Trim	End Wall Flashing	Valley Cap	Snow Guard	Trim Coil	Brush-on Touch-up Paint	Glacier White						Royal Brown
																					Hartford Green
																					Classic Blue
																					T-tone
																					Sandtone
																					Statuary Bronze
																					Pewter
																					Desert Tone
																					Classic Red
																					Charcoal Gray
																					Spruce Green
																					Bright Red
																					Copper
																					Cedar
																					Stone



**Creating Quality Exteriors Since 1946**

8700 Excelsior Boulevard • Hopkins, MN 55343  
PH: 952.945.2680 • TF: **800.593.2680** • FX: 952.938.9244  
**[www.edcoproducts.com](http://www.edcoproducts.com) • [sales@edcoproducts.com](mailto:sales@edcoproducts.com)**

9106-000 06/10 1500